

Universidad Nacional Pedro Henríquez Ureña

Departamento de Educación Física

Unión Deportiva Universitaria

III Universiada Nacional 1992

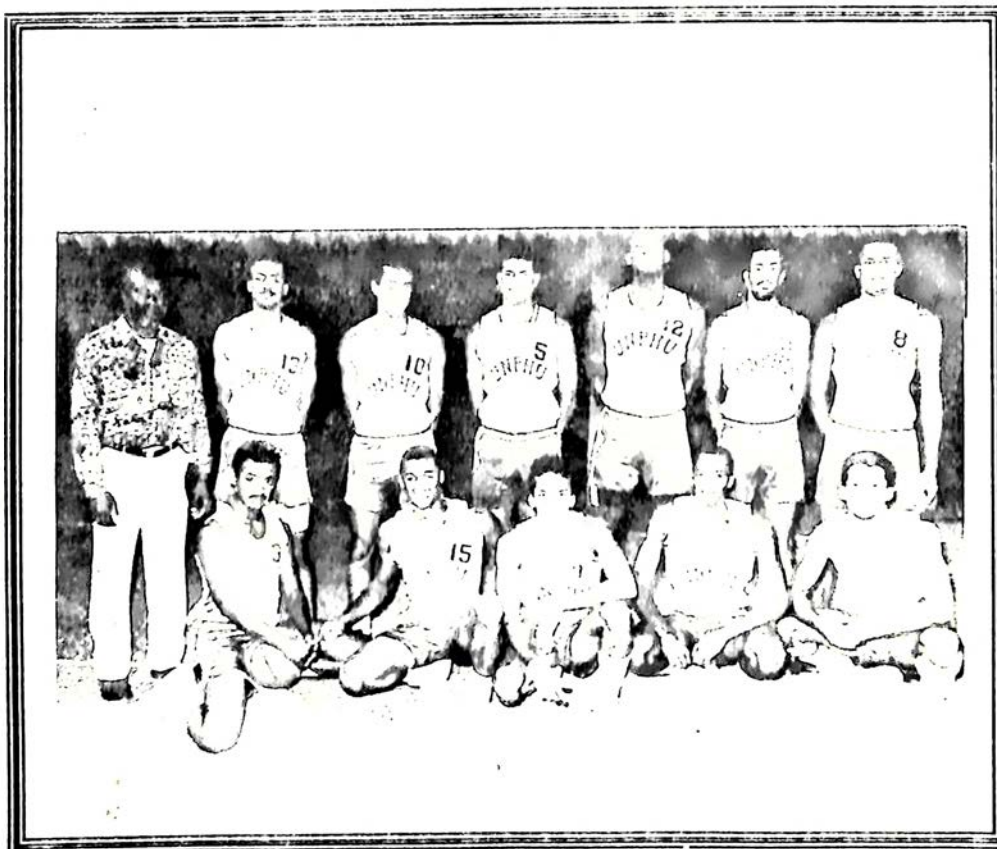

MEMORIA

Sto.Dgo. D.N

4 de Mayo de 1992

"TODO AQUEL QUE TENGA ALGO QUE ENSEÑAR O APRENDER SERA BIEN RECIBIDO"

Estas MEMORIAS fueron elaboradas
en el Dpto. de Educación Física
de la UNPHU que dirige el Prof.
ROLANDO MIRANDA y la portada en
la Imprenta UNPHU. 4 Mayo 1992

La Universidad Nacional Pedro Henríquez Ureña (UNPHU) asumió la responsabilidad de organizar y celebrar la III Universiada Nacional 1992, evento - este que ha venido a llenar un vacío que había en el deporte universitario nacional.

La UNPHU no escatimó esfuerzo para que dicho evento se desarrollara con la mayor brillantez posible.

Participaron trece centros de Educación Superior del país en 13 disciplinas y más de mil estudiantes-atletas, los cuales estuvieron compitiendo y compartiendo esta actividad del 20 de marzo al 11 de abril de 1992, en las instalaciones deportivas de las Universidades participantes, el Centro Olímpico Juan Pablo Duarte y el Club San Lázaro.

Por tercer año el deporte universitario se vistió de gala con este evento que es auspiciado por la Unión Deportiva Universitaria (UDU). Esperamos su continuidad para la superación del deporte universitario nacional.

La UNPHU quiere dejar constancia de su agradecimiento a CODETEL por su colaboración al donar todos los trofeos de premiación, así como a los miembros de las Fuerzas Armadas que realizaron la exhibición de salto en paracaídas el día inaugural, también al Club San Lázaro que nos cedió sus instalaciones para la final de Voleibol y las competencias de Karate y Tae - Kwon Do.

Nuestro agradecimiento por igual a cada una de las Instituciones de Educación Superior que compartieron con nosotros esta fiesta deportiva.

Presentamos estas Memorias como un testimonio de este gran evento.

GRACIAS.

Fecha : Viernes 20 de Marzo 1992
Hora : 4:00 p.m.
Lugar : Play de Beisbol, complejo deportivo UNPHU, Campus II.

Ceremonia Inaugural

- a) Desfile de los equipos acompañados de sus respectivas madrinas.
- b) Enhestamiento de las banderas de las Instituciones participantes acorde a las notas del Himno Nacional.
- c) Palabras de apertura por el Arq. Roberto Bergés Febles, Rector de la Universidad Nacional Pedro Henríquez Ureña.
- d) Palabras del Ing. Ramón Pinedo, Presidente de la Unión Deportiva Universitaria.
- e) Juramento Deportivo por el estudiante-atleta de la UNPHU, Carlos Martínez.
- f) Salto en paracaídas por miembros de las Fuerzas Armadas Dominicanas.
- g) Inicio de las competencias de Ajedrez, Baloncesto y Softbol.
 - 1) Primera Movera en Ajedrez, por un representante de la Federación Dominicana de esa disciplina.
 - 2) Saque de Honor en Baloncesto, por el Ing. Ezequiel García Taxis, Vicerrector de Desarrollo de la UNPHU, en la cancha de la UNPHU.
 - 3) Inicio torneo softbol con dos partidos en el play de la Universidad Autónoma de Santo Domingo.

INSTITUCIONES PARTICIPANTES

1	UNIVERSIDAD AUTONOMA DE SANTO DOMINGO	UASD
2	PONTIFICIA UNIVERSIDAD CATOLICA MADRE Y MAESTRA	PUCMM
3	UNIVERSIDAD ACCION PRO EDUCACION Y CULTURA	UNAPEC
4	INSTITUTO TECNOLOGICO DE SANTO DOMINGO	INTEC
5	UNIVERSIDAD CENTRAL DEL ESTE	UCE
6	UNIVERSIDAD TECNOLOGICA DE SANTIAGO	UTESA
7	UNIVERSIDAD ORGANIZACION Y METODO	O&M
8	UNIVERSIDAD INTERAMERICANA	UNICA
9	UNIVERSIDAD CENTRO DE ESTUDIOS PROFESIONALES	CDEP
10	UNIVERSIDAD IBEROAMERICANA	UNIBE
11	UNIVERSIDAD CATOLICA SANTO DOMINGO	UCSD
12	UNIVERSIDAD EUGENIO MARIA DE HOSTOS	UNIREMHOS
13	UNIVERSIDAD NACIONAL PEDRO HENRIQUEZ URENA	UNPHU

III UNIVERSIADA NACIONAL 1992CUADRO FINAL DE MEDALLAS

		<u>ORO</u>	<u>PLATA</u>	<u>BRONCE</u>	<u>TOTAL</u>		
*					*		
*					*		
*	1	UNPHU	43	45	33	121	*
*						*	
*	2	OEM	30	18	28	76	*
*						*	
*	3	UASD	18	18	18	54	*
*						*	
*	4	PUCMM	5	9	8	22	*
*						*	
*	5	UTESA	5	6	2	13	*
*						*	
*	6	UNAPEC	4	1	6	11	*
*						*	
*	7	INTEC	0	3	5	8	*
*						*	
*	8	UNIBE	2	3	2	7	*
*						*	
*	9	UNICA	0	1	0	1	*
*						*	
*	10	UCE	0	0	1	1	*
*						*	
*	11	CDEP	0	0	1	1	*
*						*	
*	-	UCSD	0	0	0	0	*
*						*	
*	-	UNIREMHOS	0	0	0	0	*
*						*	
*						*	
*						*	

III UNIVERSIADA NACIONAL 1992

POSICION POR DISCIPLINA

			1	2	3	4	5	6	7	8
1	AJEDREZ	M	UNPHU	INTEC	O & M	UCSD	UNIREM	CDEP	UASD	-
		F	UNPHU	INTEC	O & M	UNIREM	UASD	-	-	-
2	ATLETISMO	M	O & M	UNPHU	UASD	UNIBE	UCSD	-	-	-
		F	UASD	UNPHU	O & M	-	-	-	-	-
3	BALONCESTO	M	UNPHU	O & M	UNWPEC	UASD	UNIBE	UTESA	UCSD	INTEC
		F	O & M	UASD	-	-	-	-	-	-
4	BEISBOL	M	UASD	UNIBE	O & M	PUCMM	UNPHU	-	-	-
5	FUTBOL	M	UASD	UNPHU	-	-	-	-	-	-
6	JUDO	M	UNPHU	PUCMM	O & M	UNIBE	UTESA	UASD	UCE	-
		F	O & M	UNPHU	UASD	-	-	-	-	-
7	KARATE	M-F	UASD	UTESA	PUCMM	O & M	UNPHU	CDEP	UNWPEC	-
8	NATACION	M	UNPHU	UNWPEC	O & M	CDEP	-	-	-	-
		F	UNPHU	UNWPEC	O & M	-	-	-	-	-
9	SOFTBOL	M	UNPHU	UNICA	UNWPEC	O & M	UTESA	UCSD	UASD	UNIBE
10	TAE KWON DO	M-F	O & M	UNPHU	UASD	INTEC	-	-	-	-
11	TENIS	M	O & M	UNPHU	UNIBE	INTEC	UNWPEC	-	-	-
		F	UNPHU			-	-	-	-	-
12	TENIS DE MESA	M	UTESA	UASD	UNPHU	INTEC	UNIBE	PUCMM	UNIREM	-
		F	UTESA	UASD	UNPHU	INTEC	-	-	-	-
13	VOLEIBOL	M	UNPHU	UASD	UTESA	O & M	PUCMM	UNIBE	UNWPEC	UCSD
		F	UNPHU	UASD	O & M	UNWPEC	BUCCMM	UTESA	UCSD	-

RELACION DE MEDALLAS POR DISCIPLINA

		UNPHU			O & M			U A S D			PUCMM			UTESA			UNAPEC			INTEC			UNIBE			UNICA			UCE			CCEP			ENTRENHOS		
		R	O	P	B	O	P	B	O	P	B	O	P	B	O	P	B	O	P	B	O	P	B	O	P	B	O	P	B	O	P	B					
1	AJEDREZ	M	1				1																														
		F	1				1																														
2	ATLETISMO	M	4	6	3	4	4	9	5	4	2										1																
		F	3	7	4	3	2	3	7	4	5																										
3	BALONCESTO	M	1				1									1																					
		F				1				1																											
4	BEISBOL	M					1	1													1																
5	FUTBOL	M		1				1																													
6	JUDO	M	4	3	1		1	7			1	3	3	1		1	1					1							1								
		F	2	2	4	4	2	1		1	2		1																								
7	KARATE	MF	2		3	5	3	2	3	2	3	2	5	3	1	3																		1			
8	NATACION	M	6	7	6	1	3	1								4	1	3																			
		F	1	0	3	5											1																				
9	SOFTBOL	M	1													1									1												
10	TAE KWON DO	MF	2	8	1	9	2	1	1	1	3										1																
11	TENIS	M		2	1	3															1		1	1													
		F	1	1	2																																
12	TENIS MESA	M	3		1			1	1			3	1	1							1	2		1	1												
		F			2			2	1			1	3	1								1															
13	VOLEIBOL	M	1					1							1																						
		F	1					1		1																											
TOTALES-----			43	45	33	30	18	20	18	18	18	5	9	8	5	6	2	4	1	6	0	3	5	2	3	2	0	1	0	0	0	0	1	0	0	0	

MEDALLAS EN LAS UNIVERSIADAS CELEBRADASI UNIVERSIADA 1990

	<u>O</u>	<u>P</u>	<u>B</u>	<u>Total</u>
1 UNPHU	40	22	25	93
2 UASD	26	21	14	61
3 O & M	15	171	12	44
4 U C E	2	6	5	13
5 C D E P	2	1	3	6
6 UNIBE	1	2	1	4
7 UTESA	1	1	2	4
8 INTEC	0	2	1	3
9 UNICA	0	0	1	1
10 UNIREMHOS	0	0	1	1

II UNIVERSIADA 1991

	<u>O</u>	<u>P</u>	<u>B</u>	<u>Total</u>
1 UNPHU	22	19	13	54
2 UASD	21	10	11	42
3 O & M	12	11	19	42
4 PUCMM	4	7	3	14
5 U C E	1	2	3	6
6 INTEC	0	3	1	4
7 UNIREMHOS	2	1	0	3
8 UTESA	0	1	1	2
9 UNIBE	1	0	0	1
10 UNICA	0	1	0	1
- C D E P	0	0	0	0

III UNIVERSIADA 1992

	<u>O</u>	<u>P</u>	<u>B</u>	<u>Total</u>
1 UNPHU	43	45	33	121
2 O & M	30	18	28	76
3 UASD	18	18	18	54
4 PUCMM	5	9	8	22
5 UTESA	5	6	2	13
6 UNAPEC	4	1	6	11
7 INTEC	0	3	5	8
8 UNIBE	2	3	2	7
9 UNICA	0	1	0	1
10 U C E	0	0	1	1
11 C D E P	0	0	1	1
- UCSD	0	0	0	0
- UNIREMHOS	0	0	0	0

<u>TOTAL GENERAL</u>				
	<u>O</u>	<u>P</u>	<u>B</u>	<u>Total</u>
1 UNPHU	105	86	71	262
2 O & M	57	46	59	162
3 UASD	65	49	43	157
4 PUCMM	9	16	11	36
5 U C E	3	8	9	20
6 UTESA	6	8	5	19
7 INTEC	0	8	7	15
8 UNIBE	4	5	3	12
9 UNAPEC	4	1	6	11
10 C D E P	2	1	4	7
11 UNIREMHOS	2	1	1	4
12 UNICA	0	2	1	3
- UCSD	0	0	0	0

CAMPEONES UNIVERSIADAS CELEBRADAS

			1 ^A . 90	2 ^A . 91	3 ^A . 92
1	AJEDREZ	M	UASD	U.A.S.D.	UNPHU
		F	U.A.S.D.	U.A.S.D.	U.N.P.H.U.
	ATLETISMO	M	O & M	U.A.S.D.	O & M
		F	U.A.S.D.	U.A.S.D.	U.A.S.D.
	BALONCESTO	M	O & M	O & M	U.N.P.H.U.
		F	O & M	O & M	& M
4	BEISBOL	M	UASD-UCE UNPHU	U.N.P.H.U. U.A.S.D.	U.A.S.D.
5	FUTBOL	M	U.N.P.H.U.	UASD-O & M	U.A.S.D.
6	JUDO	M	U.N.P.H.U.	U.N.P.H.U.	U.N. P.H.U.
		F	U.N.P.H.U.	U.N.P.H.U.	O & M
7	KARATE	M-F	U.A.S.D.	U.A.S.D.	U.A.S.D.
8	NATACION	M	U.N.P.H.U.	-	U.N.P.H.U.
		F	U.N.P.H.U.	-	U.N.P.H.U.
9	SOFTBOL	M	O & M	U.N.P.H.U.	U.N.P.H.U.
10	TAE KWON DO	M-F	O & M	O & M	O & M
11	TENIS	M	U.N.P.H.U.	U.N.P.H.U.	O & M
		F	U.N.P.H.U.	U.N.P.H.U.	U.N.P.H.U.
12	TENIS DE MESA	M	U.A.S.D.	UNIREMHOS	UTESA
		F	U.A.S.D.	U.A.S.D.	UTESA
13	VOLEIBOL	M	UNIBE	UNPHU	UNPHU
		F	UNPHU	U.A.S.D.	U.N.P.H.U.

-UNPHU-

AJEDREZ

La competencia de AJEDREZ de la III Universiada Nacional se desarrollo en la sala deportiva del Departamento de Educación Física de la Universidad Nacional Pedro Henríquez Ureña (UNPHU) durante los días 20, 21, 22 y 28 de marzo de - 1992.

Participaron siete equipos masculino y cinco femenino y se jugó por el sistema de todos - contra todos a una vuelta. Los equipos de la UASD por problemas interno entre los jugadores de esa Institución se retiraron en la segunda - ronda.

Los equipos masculino y femenino de la - UNPHU resultaron campeones. El equipo femenino ganó el torneo invicto sin perder una sola partida de doce que celebró.

<u>Posición Final de los Equipos</u>				
<u>Masculino</u>		<u>Femenino</u>		
1	UNPHU	20	1 UNPHU	12
2	INTEC	18	2 INTEC	8
3	O&M	15	3 O&M	7
4	UCSD	13.5	4 UNIREMHOS	2
5	UNIREMHOS	9	5 UASD	0
6	CDEP	8		
7	UASD	0		

Nómina Equipos Participantes

U. N. P. H. U.

Masculino

- 1 Damian López
- 2 William Puntier
- 3 Teófilo Mesa
- 4 Yony Acevedo
- 5 Enerio Santana
- 6 Alex Beltrez

Femenino

- 1 Mirian Romero
- 2 Carmen B. Montilla
- 3 Wanda del Rosario
- 4 Tania Santos
- 5 Aquilina Figueroa

I. N. T. E. C.

Masculino

- 1 Manuel Rodríguez
- 2 Miguel Sánchez
- 3 Alberto Angó Es
- 4 Juan Peralta
- 5 Federico Tineo
- 6 Barleny Muñoz

Femenino

- 1 Natasha Gómez
- 2 Onalis Cuesta
- 3 Susana Grullón
- 4 Scarlett Fondeur

O. E. M.

Masculino

- 1 Julio Vargas
- 2 Daniel Abreu
- 3 William Arias
- 4 Carlos Gil Pascual
- 5 José Pimentel
- 6 Daniel E. Muñoz

Femenino

- 1 Nancy I. Feliz
- 2 Wendy Vasquez Casado
- 3 Honey Vanery Casado

UNIREMHOS

Masculino

- 1 José Díaz
- 2 Enrique Ibañez
- 3 Pedro Mota
- 4 Sergio Sarita

Femenino

- 1 Gloria María Jon
- 2 Rosalina Jon

U. C. S. D.

Masculino

- 1 Fausto Puntier
- 2 Camilo Muñoz
- 3 Rubén Puntier
- 4 Héctor Fermín

C. D. E. P.

Masculino

- 1 Miguel Burgos P.
- 2 Diego César García
- 3 Elvis Enerio Santana
- 4 Francisco Ml. Marte C.

Cuadro de Participantes

		<u>V</u>	<u>H</u>	<u>TOTAL</u>
1	UNPHU	6	5	11
2	INTEC	6	4	10
3	O&M	6	3	9
4	UNIREMHOS	4	2	6
5	U C S D	4	0	4
6	C D E P	4	0	4
7	UASD	6	4	10
		<u>36</u>	<u>18</u>	<u>54</u>

ACTUACION INDIVIDUAL POR TABLERO

12

Masculino1eros Tableros

<u>1</u>	<u>Nombre</u>	<u>Institución</u>	<u>Ptos.</u>
1	DAMIAN LOPEZ	UNPHU	4
2	Manuel Rodríguez	Intec	3.5
3	Julio Vargas	O&M	3.5
4	Fausto Puntier	UCSD	3
5	Miguel Burgos	CDEP	0.5
6	José Díaz	UNTREMOS	0

2dos. Tableros

1	WILLIAM PUNTIER	UNPHU	5
2	Camilo Muñoz	UCSD	3
3	Daniel Abreu	O&M	2.5
4	Miguel Sánchez	INTEC	2
5	Enrique Ibañez	UNIREMHOS	2
6	Diego César García	CDEP	0

3ros. Tableros

1	TEOFILO MESA	UNPHU	4
2	William Arias	O&M	2.5
3	Rubén Puntier	UCSD	1.5
4	Elvis Enerio Santana	CDEP	1.5
5	Alberto Angeles	INTEC	0
6	Pedro Mota	UNIREMHOS	0

4tos. Tableros

1	JUAN PERALTA	INTEC	3.5
2	SERGIO SARITA	UNIREMHOS	3.5
3	Yony Acevedo	UNPHU	3
4	Héctor Fermín	UCSD	3
5	Carlos Ml. Pascual	O&M	1.5
6	Frank Ml. Marte	CDEP	1

Mejor Suplente

1	FEDERICO TINERO	INTEC	3
2	Daniel Nájuez	O&M	1
3	Francisco Canahuate	CDEP	1

ACTUACION INDIVIDUAL POR TABLEROFemenino1ros. Tableros

1	MIRIAN ROMERO	UNPHU	3
2	Natasha Gómez	Intec	2
3	Nancy Félix	O&M	1
4	Gloria Ma. Jon	UNIREMHOS	0

2dos. Tableros

1	CARMEN BEATRIZ MONTILLA	UNPHU	3
2	Wendy Vasquez	O&M	2
3	Onalis Cuesta	INTEC	1
4	Rosalina Jon	UNIREMHOS	0

3ros. Tableros

1	WANDA DEL ROSARIO	UNPHU	3
2	Susana Guillén	INTEC	2
3	Honey Casado	O&M	1

*			*
*			*
*	<u>MEJORES TABLEROS</u>		*
*			*
*	<u>Masculino</u>		*
*			*
*	1ro. DAMIAN LOPEZ	UNPHU	*
*	2do. WILLIAM PUNTIR	UNPHU	*
*	3ro. TEOFILO MESA	UNPHU	*
*	4to. JUAN PERALTA	INTEC	*
*	4to. SERGIO SARITA	UNIREMHOS	*
*	Suplente: FEDERICO TINEO	INTEC	*
*			*
*			*
*	<u>Femenino</u>		*
*			*
*	1ro. MIRIAN ROMERO	UNPHU	*
*	2do. CARMEN B. MONTILLA	UNPHU	*
*	3ro. WANDA DEL ROSARIO	UNPHU	*
*			*
*			*

RESULTADOS POR EQUIPOMASCULINO

		1	2	3	4	5	6	7	Ptos
1	UNPHU		3	2.5	3.5	3	4	4	20
2	INTEC	1		3	2.5	3	3.5	4	18
3	O & M	1.5	1		2	2.5	4	4	15
4	UCSD	0.5	1.5	2		2.5	2.5	4	13.5
5	UNIREMHOS	1	1	1.5	1.5		2	4	9.5
6	CDEP	0	0.5	0	1.5	2		4	8
7	UASD	0	0	0	0	0	0		0

FEMENINO

		1	2	3	4	5	Ptos
1	UNPHU		3	3	3	3	12
2	INTEC	0		2	3	3	8
3	O & M	0	1		3	3	7
4	UNIREMHOS	0	0	0		2	2
5	UASD	0	0	0	0		0

RESULTADOS INDIVIDUALES POR RONDA

			RONDAS					TOTAL PUNTOS
			1ra.	2da.	3ra.	4ta.	5ta.	
1	Damian López	UNPHU	19	17	23	13	27	4
2	William Puntier	"	20	21	24	14	28	5
3	Tebfilo Mesa	"	21	10	25	15	29	4
4	Yony Acevedo	"	22	12	-	16	30	3
5	Enerio Santana	"	-	-	26	0	-	0
6	Alex Beltrés	"	-	-	-	-	-	0
7	Manuel Rodríguez	INTEC	23	19	13	13	28	3.5
8	Miguel Sánchez	"	24	20	-	14	30	3
9	Alberto Angeles	"	-	-	2	0	-	0
10	Juan Peralta	"	25	21	3	3	29	3.5
11	Federico Tinzo	"	-	22	1	-	32	3
12	Marleny Muñoz	"	26	0	4	0	-	0
13	Julio Vargas	O&M	27	23	7	19	23	3.5
14	Daniel Abreu	"	28	25	8	20	22	2.5
15	William Arias	"	29	-	9	21	25	2.5
16	Carlos M. Pascual	"	30	-	10	1	4	1.5
17	José Pimentel	"	-	24	0	-	-	0
18	Daniel E. Muñoz	"	-	26	0.5	-	22	1
19	Fausto Puntier	UCSD	1	7	13	13	23	3
20	Camilo Muñoz	"	2	8	17	14	24	3
21	Rubén Puntier	"	3	10	30	15	25	1.5
22	Héctor Fermín	"	4	11	32	18	26	3
23	José Díaz	UNIREMHOS	7	29	13	0	19	0
24	Enrique Ibañez	"	8	30	17	2	20	2
25	Pedro Mota	"	10	14	-	3	21	0
26	Sergio Sarita	"	2	31	18	5	22	3.5
27	Miguel Burgos	CDE?	13	-	20	0.5	1	0.5
28	Diego César García	"	14	-	-	7	0	0
29	Elvis Enerio Santana	"	15	23	19	10	3	1.5
30	Frank M. Marte	"	16	24	21	1	4	1
31	Elias Ortega	"	-	26	0	-	-	0
32	Francisco Canahuato	"	-	25	22	1	1	1

RESULTADOS INDIVIDUALES POR RONDA

FEMENINO

			R O N D A S						TOTAL PUNTOS
			1ra.		2da.		3ra.		
1	MIRIAN ROMERO	UNPHU	11	1	13	1	5	1	3
			1		2		3		
2	CARMEN B. MONTILLA	"	12	1	14	1	8	1	3
			1		2		3		
3	WANDA DEL ROSARIO	"	0	1	15	1	10	1	3
			1		2		3		
4	TANIA SANTOS	"	-	-	-	-	-	-	0
			-	-	-	-	-	-	
5	NATASHA GOMEZ	INTEC	0	1	1	0	11	1	2
			1		1		2		
6	GUILLERMINA ROSARIO	"	-	-	-	-	-	-	0
			-	-	-	-	-	-	
7	ONALIS CUESTA	"	14	0			12	1	1
			0				1		
8	SUSAN GUILLEN	"	15	1	2	0	14	1	2
			1		1		2		
9	ROSMERY ESPINAL	"	-	-	-	-	-	-	0
			-	-	-	-	-	-	
10	SCARLETT FONDEUR	"	-	-	3	0	-	-	0
			-	-	0		-	-	
11	GLORIA MARIA JON	UNIREMHOS	1	0	5	0	13	0	0
			0		0		0		
12	ROSALINA JON	"	2	0	6	0	14	0	0
			0		0		0		
13	NANCY FELIZ	O & M	-	-	1	0	11	1	1
			-	-	0		1		
14	WENDY VASQUEZ	"	7	1	2	0	12	1	2
			1		1		2		
15	HONEY CASADO	"	8	0	3	0	16	1	1
			0		0		1		

NOMINA DE PARTICIPANTES ATLETISMO

O & M

Masculino

- 1 Carlos Acosta
- 2 Elvis Rosa
- 3 Jerje Hernández
- 4 Erick Meregildo
- 5 Bernardo Leceña
- 6 Rafael González
- 7 Felix Ozoria
- 8 Juan R. Romero
- 9 Juan R. Marrero
- 10 Leocadio Pérez
- 11 Leonardo Cruz
- 12 José Luis Pérez
- 13 Abraham Bauxista
- 14 Luis H. Borilla
- 15 Rubén Castillo
- 16 Marino Trinidad
- 17 Guillermo Valdez
- 18 Dionny Medrano

Femenino

- 1 Juana Nin
- 2 Alba Reyes
- 3 Yannette Mante
- 4 Elsa Peña
- 5 Dilcia Díaz
- 6 Generosa Jorge
- 7 Casilda Matos
- 8 Elizabeth Hernández

U A S D

Masculino

- 1 Gregorio Cruz
- 2 Victor Samboy
- 3 Eduardo Suriñach
- 4 Teófilo Alcántara
- 5 Wellington Núñez
- 6 Andrés Mateo
- 7 Gregorio Quezada
- 8 Román Celedonio
- 9 Luis E. Cuesta
- 10 Luis Matos
- 11 Reynaldo Guerrero
- 12 Guillermo Nolasco

U.C.S.D

- 1 Juan A. Guerrero

U A S D

Femenino

- 1 María González
- 2 Erika Matos
- 3 Vicenta Payano
- 4 Amadesis Batista
- 5 Kenia Bastardo
- 6 Sobeida Uribe
- 7 Rosa Tiburcio
- 8 Damaris Pérez
- 9 Laura Santos
- 10 Cándida Asencio
- 11 Gimmy Piñeyro
- 12 Eulogia Valera

U N P H U

Masculino

- 1 Lizandro Cruzeta
- 2 Carlos Guzmán Mateo
- 3 José García Ortiz
- 4 Santiago Hernández
- 5 Eddy García
- 6 Pedro Martínez
- 7 Daniel Núñez Polanco
- 8 Héctor R. Diloné
- 9 Nicolás Acevedo
- 10 Daniel Leoncio Tereyra
- 11 Marcos Durán
- 12 Yovanny Reyes
- 13 Emilio Wells

Femenino

- 1 Ruth Gómez
- 2 Jenny Guzmán
- 3 Carmen Puntier
- 4 Niurka Rodríguez
- 5 Rita de la Rosa
- 6 Josefina A. Comprés
- 7 Divina Mejía
- 8 Yenny Aguasviva
- 9 Esperanza Graciano
- 10 Aquilina Figueroa

U N I B E

- 1 Antonio Jerez

Cuadro de Participación

		V	H	TOTAL
1	UASD	12	12	24
2	O & M	18	8	26
3	UNPHU	13	10	23
4	UNIBE	1	0	1
5	UCSD	1	0	1
		<u>45</u>	<u>30</u>	<u>75</u>

R E S U L T A D O S

19

100 METROS PLANOS

1	Lizandro Cruzeta	UNPHU	11.09
2	Carlos Guzmán Mateo	UNPHU	11.16
3	Carlos Acosta Matos	OEM	11.63
4	Gregorio Cruz	UASD	11.70
5	Elvis Roa	OEM	11.82
6	Víctor Samboy	UASD	12.14
7	Juan A. Guerra	UCSD	14.80

200 METROS PLANOS

1	Lizandro Cruzeta	UNPHU	22.45
2	Jerje Hernández	OEM	22.47
3	Carlos Acosta	OEM	23.55
4	Edward Suriñach	UASD	24.35
5	José García Ortiz	UNPHU	24.83
6			

400 METROS PLANOS

1	Jerje Hernández	OEM	50.60
2	Teófilo Alcántara	UASD	52.98
3	Erick Merregildo	OEM	53.60
4	Santiago Hernández	UNPHU	1.10.10

800 METROS PLANOS

1	Teófilo Alcántara	UASD	2.00.38
2	Bernardo Ledesma	OEM	2.06.66
3	Rafael González	OEM	2.10.11

1.500 METROS PLANOS

1	Wellington Núñez	UASD	4.05.60
2	Félix Osoria	OEM	4.08.31
3	Juan R. Romero	OEM	4.20.40
4	Eddy García	UNPHU	4.23.00
5	Andrés Mateo	UASD	4.25.00

5.000 METROS PLANOS

1	Gregorio Quezada	UASD	16.49.00
2	Wellington Núñez	UASD	16.50.40
3	Félix Osoria	OEM	17.15.80
4	Juan R. Marreno	OEM	17.41.25
5	Pedro Martínez	UNPHU	18.30.10

10.000 METROS PLANOS

20

1	Leocadio Pérez	O&M	33.52.36
2	Román Celedonio	UASD	34.21.70
3	Pedro Martínez	UNPHU	35.31.00
4	Leonardo Cruz Francisco	O&M	36.08.21

110 METROS VALLAS

1	Daniel Nájuez	UNPHU	16.60
2	Gregorio Cruz	UASD	17.56
3	Joselito Pérez	O&M	18.54

LANZAMIENTO DE LA BALA

1	Antonio Jerez	UNIBE	9.54
2	Héctor R. Diloné	UNPHU	8.83
3	Luis E. Cuesta	UASD	8.67
4	Abraham Bautista	O&M	7.83
5	Luis Manuel Bonilla	O&M	7.43
6	Jesús A. Matos	UASD	7.20

LANZAMIENTO DEL DISCO

1	Reynandl Guerrero	UASD	35.80
2	Daniel Leoncio	UNPHU	33.35
3	Marcos Durán	UNPHU	31.75
4	Antonio JEREZ	UNIBE	29.40
5	Rubén Castillo	O&M	23.80
6	Marino Trinidad	O&M	22.40

LANZAMIENTO DE LA JABALINA

1	Marino Trinidad	O&M	49.72
2	Daniel Leoncio	UNPHU	48.77
3	Rubén Castillo	O&M	36.64
4	Jesús Matos	UASD	32.21

SALTO LARGO

1	Daniel Nájuez	UNPHU	6.30
2	Carlos Guzmán	UNPHU	6.00
3	Guillermo Valdez	O&M	5.24
4	Dionni Medrano	O&M	4.90

RELEVO 4 x 100 METROS PLANOS

21

1	Carlos Acosta Elvis Luna Joselito Pérez Jerje Hernández	O&M	45.25.00
2	Daniel Nájiz Joyanny Reyes R. Emilio Wells Lizandro Cruzeta	UNPHU	46.02.00
3	Víctor Samboy Edward Suriñach Teófilo Alcántara Guillermo Nolasco	UASD	47.07.00

RELEVO 4 x 400 METROS PLANOS

1	Guillermo Nolasco Wellington Nájiz Edward Suriñach Teófilo Alcántara	UASD	3.30.42
2	Erick Meregildo Jerje Hernández Bernardo Ledesma Rafael González	O&M	3.36.29
3	Emilio Wells Daniel Nájiz Lizandro Cruzeta Eddy García	UNPHU	3.39.80

F E M E N I N O

22

100 METROS PLANOS

1	Ruth Gómez	UNPHU	12.80
2	María González	UASD	13.15
3	Erika Matos	UASD	13.32
4	Juana Nin	O&M	14.06
5	Alba Reyes	O&M	14.28
6	Jenny Guzmán	UNPHU	14.83

200 METROS PLANOS

1	María González	UASD	27.41
2	Ruth Gómez	UNPHU	27.57
3	Carmen Puntier	UNPHU	28.79
4	Alba Reyes	O&M	30.21
5	Juana Nin	O&M	32.78
6	Adalgisa Rivera	UASD	36.25

400 METROS PLANOS

1	Niurka Rodríguez	UNPHU	1.07.00
2	Vicenta Payano	UASD	1.16.22
3	Amadesis Batista	UASD	1.20.00

800 METROS PLANOS

1	Rita de la Rosa	UNPHU	2.49.88
2	Josefina A. Comprés	UNPHU	2.58.66
3	Kenia Bastardo	UASD	3.04.60
4	Janet Marte	O&M	3.07.29

1.500 METROS PLANOS

1	Sobeida Uribe	UASD	5.23.00
2	Divina Mejía	UNPHU	5.52.56
3	Yenny Aguasviva	UNPHU	7.31.00

3.000 METROS PLANOS

1	Sobeida Uribe	UASD	12.32.16
2	Divina Mejía	UNPHU	13.57.23
3	Josefina A. Comprés	UNPHU	15.00.00

100 METROS VALLAS

1	Elsa Peña	O&M	15.38
2	Rosa Tiburcio	UASD	17.82
3	Niurka Rodríguez	UNPHU	20.42

LANZAMIENTO DE LA BALA

1	Dilcia Díaz	O&M	8.58
2	Esperanza Graciano	UNPHU	8.22
3	Damaris Pérez	UASD	6.48
4	Genoveva Jorge	O&M	5.34
5	Laura Santos	UASD	5.26

LANZAMIENTO DEL DISCO

1	Cándida Asencio	UASD	29.68
2	Casilda Matos	O&M	25.24
3	Genoveva Jorge	O&M	17.04

LANZAMIENTO DE LA JABALINA

1	Cándida Asencio	UASD	35.60
2	Dilcia Díaz	O&M	27.04
3	Casilda Matos	O&M	23.94
4	Esperanza Graciano	UNPHU	22.37
5	Aquilina Figueroa	UNPHU	19.12
6	Genny Piñeyro	UASD	18.00

SALTO LARGO

1	Elsa Peña	O&M	5.25
2	Erika Matos	UASD	4.50
3	Rosa Tiburcio	UASD	4.45
4	Jenny Guzmán	UNPHU	3.87
5	Yenny Aguasviva	UNPHU	3.65
6	Elizabeth Hernández	O&M	3.51

RELEVO 4 x 100 METROS

	Rosa Tirucio		
1	Cándida Asencio	UASD	52.74.00
	Erika Matos		
	María González		
	Carmen Puntier		
2	Niurka Rodríguez	UNPHU	53.3200
	Aquilina Figueroa		
	Ruth Gómez		
	Alba Reyes		
3	Dilcia Díaz, Elsa Peña	O&M	53.54.00
	Juana Nin		

RELEVO 4 x 400 METROS

1	Eulogia Valera, Sobeida Uribe	UASD	4.31.25
	Cándida Asencio, Erika Matos		
	Divina Mejía, Ruth Gómez		
2	Niurka Rodríguez	UNPHU	4.52.12
	Rita de la Rosa		

POSICION Y PUNTUACION POR EVENTO ATLETISMOMASCULINO

		1	2	3	4	5	6	UNPHU	O&M	UASD	UNIBE
1	100 Mts. Planos	UNPHU	UNPHU	O&M	UASD	O&M	UASD	12	6	4	-
2	200 Mts. Planos	UNPHU	O&M	O&M	UASD	UNPHU	-	9	9	3	-
3	400 Mts. Planos	O&M	UASD	O&M	UNPHU	-	-	3	11	5	-
4	800 Mts. Planos	UASD	O&M	O&M	-	-	-	0	9	7	-
5	1,500 Mts. Planos	UASD	O&M	O&M	UNPHU	UASD	-	3	9	9	-
6	5,000 Mts. Planos	UASD	UASD	O&M	O&M	UNPHU	-	2	7	12	-
7	10,000 Mts. Planos	O&M	UASD	UNPHU	O&M	-	-	4	10	5	-
8	110 Mts. Vallas	UNPHU	UASD	O&M	-	-	-	7	4	5	-
9	LANZ. BALA	UNIBE	UNPHU	UASD	O&M	O&M	UASD	5	5	5	7
10	LANZ. DISCO	UASD	UNPHU	UNPHU	UNIBE	O&M	O&M	9	3	7	3
11	LANZ. JABALINA	O&M	UNPHU	O&M	UASD	-	-	5	11	3	-
12	SALTO LARGO	UNPHU	UNPHU	O&M	O&M	-	-	12	7	-	-
13	RELEVO 4 x 100 Mts.	O&M	UNPHU	UASD	-	-	-	5	7	4	-
14	RELEVO 4 x 400 Mts.	UASD	O&M	UNPHU	-	-	-	4	5	7	-

TOTAL MASCULINO-- 80 10376 10

FEMENINO

		1	2	3	4	5	6	UNPHU	O&M	UASD	UNIBE
1	100 Mts. Planos	UNPHU	UASD	UASD	O&M	O&M	UNPHU	8	5	9	-
2	200 Mts. Planos	UASD	UNPHU	UNPHU	O&M	O&M	UASD	9	5	8	-
3	400 Mts. Planos	UNPHU	UASD	UASD	-	-	-	7	-	9	-
4	800 Mts. Planos	UNPHU	UNPHU	UASD	O&M	-	-	12	3	4	-
5	1,500 Mts. Planos	UASD	UNPHU	UNPHU	-	-	-	9	-	7	-
6	3,000 Mts. Planos	UASD	UNPHU	UNPHU	-	-	-	9	-	7	-
7	100 Mts. Vallas	O&M	UASD	UNPHU	-	-	-	4	7	5	-
8	LANZ. BALA	O&M	UNPHU	UASD	O&M	UASD	-	5	10	6	-
9	LANZ. DISCO	UASD	O&M	O&M	-	-	-	-	9	7	-
10	LANZ. JABALINA	UASD	O&M	O&M	UNPHU	UNPHU	UASD	5	9	8	-
11	SALTO LARGO	O&M	UASD	UASD	UNPHU	UNPHU	O&M	5	8	9	-
12	RELEVO 4 x 100 METROS	UASD	UNPHU	O&M	-	-	-	5	4	7	-
13	RELEVO 4 x 400 Metros	UASD	UNPHU	-	-	-	-	5	-	7	-

TOTAL FEMENINO---

83 60 93 -

TOTAL GENERAL----

163 163169 10

BALONCESTO

El torneo de baloncesto masculino de la III Universiada Nacional fue un evento de mucho interés y bien representativo. Desde un principio se creó la expectativa de los equipos de O&M, UASD, y UNPHU.

O&M, UNPHU y UNAPEC pasaron a la final, quedando la UASD fuera de la clasificación. La UNPHU finalmente se coronó campeón invicto en cuatro partidos.-

La rama femenina, lamentablemente solo participaron dos equipos. Esperamos una mayor integración en el futuro.

<u>Posición Final de los Equipos</u>			
<u>Masculino</u>		<u>Femenino</u>	
1	UNPHU	4 - 0	1 O & M 2 - 1
2	O & M	3 - 1	2 U A S D 1 - 2
3	UNAPEC	2 - 3	
4	U A S D	2 - 1	
5	UNIBE	1 - 1	
6	UTESA	1 - 1	
7	U C S D	1 - 2	
8	INTEC	1 - 2	
9	PUCMM	0 - 2	
10	U N I C A	0 - 2	

RESULTADOS BALONCESTO MASCULINOGRUPO "A"

		1	2	3	JG	JP	PTOS.	PF	PC	DIF.
1	UNPHU		88-47	86-61	2	0	4	171	108	63
2	UNIBE	47-88		100-70	1	1	3	147	158	-11
3	PUCMM	61-86	70-100		0	2	2	131	186	-55

GRUPO "B"

		1	2	3	JG	JP	PTOS	PF	PC	DIF.
1	O&M		57-44	71-55	2	1	4	128	99	29
2	UTESA	44-57		2-0	1	1	3	46	57	-11
3	UNICA	55-71	0-2		0	2	1	73	55	-18

GRUPO "C"

		1	2	3	4	JG	JP	PTOS.	PF	PC	DIF.
1	UNAPEC		68-67	86-64	52-54	2	1	5	206	185	21
2	UASD	67-68		74-59	88-84	2	1	5	229	211	18
3	UCSD	64-86	59-74		98-84	1	2	4	221	244	-23
4	INTEC	54-52	84-88	84-98		1	2	4	222	238	-16

FINAL

		1	2	3	JG	JP	PTOS.	PF	PC	DIF.
1	UNPHU		75-69	94-74	2	0	4	169	143	26
2	O&M	69-75		2-0	1	1	3	71	75	-4
3	UNAPEC	74-94	0-2		0	2	1	74	96	-22

NOMINA DE EQUIPOS Y PUNTUACION INDIVIDUALMASCULINO

<u>U</u> <u>N</u> <u>P</u> <u>H</u> <u>U</u>		<u>O</u> <u>E</u> <u>M</u>		
1	Carlos Martínez	86	1 Eddy Lapaix	83
2	Carlos Sánchez	58	2 Héctor Lapaix	44
3	Oscar Voldez	50	3 Edmundo Amparo	28
4	Francisco Rauszell	44	4 Antonio Lapaix	13
5	Moisés Waldron	33	5 Juan Carlos Reynoso	7
6	Lince Lora	16	6 Leocadio Suarez	6
7	Leonardo Acosta	12	7 Roberto Mateo	5
8	Jesús Miranda	11	8 Roberto Martínez	5
9	Juan R. del Rosario	11	9 Roberto López	4
10	Santo Tolentino	10	10 Gerbert Lora	2
11	Edward Medina	8	11 Franklin Tolentino	1
12	Elvis Parra	4	12 Iriarte Alvarez	0
			13 Julio Tejada	0
			14 Manuel Calzado	0

<u>U</u> <u>N</u> <u>A</u> <u>P</u> <u>E</u> <u>C</u>		<u>U</u> <u>A</u> <u>S</u> <u>D</u>		
1	Omar Aponte	66	1 Adolfo Sánchez	48
2	José Pérez	42	2 Carlos Espertin	43
3	Ángel García	23	3 Ramón Peguero	28
4	José Benjamín	23	4 Eugenio Peña	21
5	José Gerónimo	22	5 Manuel Zabala	11
6	Luis Ferrand	21	6 Hilario Alcantara	10
7	Marcos Jorge	20	7 Alejandro Romero	8
8	José Inoa	13	8 Luis García	14
9	Fernando Evers	0	9 José Gil	16
10	Tomás de LEÓN	0	10 Raul González	4
			11 Raul Caminero	4
			12 J. Encarnación	2
			13 Guaroa Suero	2
			14 Wilson Cruz	0
			15 J. Gadfrey	0

<u>U</u> <u>N</u> <u>I</u> <u>B</u> <u>E</u>		<u>U</u> <u>T</u> <u>E</u> <u>S</u> <u>A</u>		
1	Franklin Vasquez	24	1 Francisco Paulino	12
2	Ernesto Sánchez	22	2 Paula R. Rubini	11
3	Moisés Cuzmán	19	3 Luis Hernández	10
4	Edwin Guerrero	16	4 Juan M. Carrasco	6
5	Esteban Mateo	14	5 Freddy García	4
6	Luis Moreno	12	6 Rafael A. Lara	2
7	Arnaldo González	10	7 Nelson Pepén	0
8	Oswaldo Villalona	8	8 Martín Rodríguez	0
9	Arnaldo Rosario	8	9 Johnny de la Cruz	0
10	Victor Nieves	4	10 Wilkin Cabrera	0
11	Alexander Ortega	3	11 Martín Pérez	0
12	Ricardo Rubio	3	12 Rafael Salcedo	0
13	Janeiro Báez	2		
14	Luis Rojas	0		

I N T E C

1	Gilberto Palma	66
2	Iván Lenderborg	53
3	Kelvin Reyes	37
4	William Lenderborg	33
5	Héctor Balcácer	15
6	Wellington Oliva	13
7	Rudyard Sosa	5
8	Flavio Mora	0
9	Erick Barinas	0
10	Víctor Teschamps	0

P U C M M

28

1	Juan Molina	34
2	Alejandro Nova	34
3	Pavel Mejía	22
4	Marcial Silvestre	20
5	Elias Salazar	6
6	Ariel Martín	5
7	Wilton Quireoz	6
8	José Mateo	0
9	José Rodríguez	0
10	Geovanny Valdéz	0

U N I C A

1	Juan Lantigua	24
2	Danid Ortiz	12
3	Miguel de la Cruz	6
4	Juan García	4
5	Luis Encarnación	2
6	Ricardo Cuevas	2
7	José Familia	2
8	Alberto Mejía	0
9	Guillermo Pérez	0
10	Isidro Zayas	0

U C S D

1	Francisco de la Cruz	57
2	Ramón Victoriano	41
3	Víctor Savery	37
4	Claudio Banks	31
5	Andrés Victoriano	17
6	Miguel Medrano	16
7	Nelson Navarro	8
8	Miguel Rivera	7
9	Ruffi Susana	3
10	Nestor Pérez Ch.	0
11	Miguel Brito	6
12	Leonardo Moreno	0
13	Emmanuel Borromé	0

MEJORES ANOTADORES

1	Carlos Martínez	UNPHU	86
2	Eddy Lapaix	O&M	83
3	Gilberto Palma	INTEC	66
4	Omar Aponte	UNAPEC	66
5	Carlos Sánchez	UNPHU	58
6	Francisco de los Santos	UCSD	57
7	Iván Lenderborg	INTEC	53
8	Oscar Valdéz	UNPHU	50
9	Adolfo Sánchez	UASD	48
10	Francisco Raussell	UNPHU	44
11	Héctor Lapaix	O&M	44
12	Carlos Espertin	UASD	43
13	José Pérez	UNAPEC	42
14	Ramón Victoriano	UCSD	41
15	Víctor Savery	UCSD	37
16	Kelvin Reyes	INTEC	37

RESULTADOS FEMENINO

		1º	2º	3º	JG	JP	PTOS.
1	O & M	72	0	72	2	1	4
2	U A S D	68	2	45	1	2	4

Puntuación Individual por Equipo

<u>O & M</u>			<u>U A S D</u>		
1	María Lebrón	43	1	Verda Trinidad	36
2	Yovanny Florian	35	2	Matilde Guerrero	27
3	Isabel Mariñez	28	3	Wendy García	25
4	Mercedes Rondón	16	4	Altagracia Mateo	10
5	Barbara Santo	12	5	Nelya González	7
6	Dulceris Victoria	7	6	M. Alcántara	4
7	Flor María Valdez	0	7	Anny Perdomo	3
8	Guillermina Reyes	0	8	Tania Mejía	1
9	Nora Lisette Escanio	0	9	Alejandra Mateo	0
10	Carmen Florentino	0	10	Rosina Perdomo	0
11	Anabel Adames	0	11	M. Monte de Oca	0
12	L. de los Santos	0			

Mejores Anotadoras

1	María Lebrón	O&M	43
2	Verda Trinidad	UASD	36
3	Yovanny Florian	O&M	35
4	Mercedes Rondón	O&M	28
5	Matilde Guerrero	UASD	27
6	Wendy García	UASD	25
7	Mercedes Rondón	O&M	16
8	Barbara Santos	O&M	12
9	Altagracia Mateo	UASD	10

BEISBOL

En esta disciplina participaron seis equipos, número bien representativo en comparación con las Universiadas anteriores.

Los equipos se dividieron en dos grupos y jugarían una final cruzada. Por razones que no vienen al caso mencionar la final la jugaron los ganadores de cada grupo. El equipo de la UASD resultó campeón.

```
*****
*
*      Posición Final      *
*
*      1  U A S D      3 - 0  *
*      2  UNIBE        2 - 1  *
*      3  O & M         1 - 1  *
*      4  PUCMM        1 - 1  *
*      5  UNPHU        0 - 2  *
*      6  UTESA        0 - 2  *
*
*****
```

<u>U A S D</u>	<u>O & M</u>	<u>U N P H U</u>
1 Eulogio Batista	1 Edelmiro Colón	1 Junior Abréu
2 Diógenes Beltres	2 Bony García	2 Angel M. Gómez
3 Geovanny Almonte	3 Edwin Rodríguez	3 Pedro Rosario
4 Sadiel Lorenzo	4 Alejandro de León	4 Eduardo Aquino
5 Pedro Medrano	5 Domingo Parra	5 Juan Tejada
6 Manuel Lebrón	6 Ramón Paredes	6 Rafael Morillo
7 Jhonny Alcántara	7 Alejandro Soto	7 Francisco Rosario
8 Francisco Rodríguez	8 Fernando Hernández	8 Miguel Paulino
9 Carlos Sánchez	9 Juan Cruz	9 Holguín Brito
10 Valerio Aquino	10 René Peralta	10 Rafael Concepción
11 Johnny Pérez	11 Fernando Mateo	11 Wilson O. Rodríguez
12 Carlos de los Sa	12 Julio Mercado	12 Pedro Peña
13 Newton Mesa	13 Dilson Brito	13 Leonardo Baldera
14 Melido Tejada	14 Ramón Mateo	14 Norberto Erock
15 Juan Mones	15 Gregorio Soto	15 Eduardo Hernández
16 Franklin Reynoso	16 Amauris García	16 William Orozco
17 Víctor Soto	17 Juan Sánchez	17 Fernando Graciano
18 Juan Reyes	18 Henry Muñoz	
	19 Leonardo Rosario	
<u>U N I B E</u>	<u>P U C M M</u>	<u>U T E S A</u>
1 Antonio González	1 Osiris Alvarado	1 Bonny Reyes
2 Rafael Grow Santana	2 Danny García	2 Juan Aybar
3 Mario López	3 Mayobanex Hernández	3 José Gómez
4 Cleder Mota	4 Gary Read	4 Alejandro Manzueta
5 Amauris Sosa	5 Carlos Gallardo	5 Víctor Almonte
6 José Rojas	6 José Guitierrez	6 Ramón Estevez
7 Ramón Pérez	7 Leo Curiel	7 Héctor Andrés
8 Luis Larry Pichardo	8 Robinson Sánchez	8 Ricardo Parra
9 Erick Gutierrez	9 Leonardo Fajardo	9 René Durán
10 Roberto Cruz	10 Nicolás Martínez	10 Luis Valera
11 Rosmel Santana	11 Junior Gómez	11 José Valenzuela
12 Pavel Aquino	12 Eduardo Hernández	12 Diómedes Durán
13 Arquímedes Ramírez	13 Víctor Ramírez	13 Jerson Placencio
14 Jorge Moja	14 Eduardo Rincón	14 Francisco Piñeyro
15 Pascual Henríquez		15 Carlos Valdéz
16 Manuel Rodríguez		16 Richard Santos
17 Alain Natea		
18 Bienvenido Rojas		
19 Francis Félix		
20 Manuel Sánchez		
21 Larry González		

<u>Cuadro de Participación</u>		
1	U A S D	18
2	U N I B E	21
3	O & M	19
4	P U C M M	14
5	U N P H U	17
6	U T E S A	<u>16</u>
Total--		105

RESULTADOS BEISBOLGrupo "A"

		1	2	3	JG	JP	AVE
1	U A S D		9-4	15-11	2	0	1000
2	O & M	4-9		8-1	1	1	500
3	U T E S A	11-15	1-8		0	2	000

Grupo "B"

		1	2	3	JG	JP	AVE
1	U N I B E		9-2	7-4	2	0	1000
2	P U C M M	2-9		5-1	1	1	500
3	U N P H U	4-7	1-5		0	2	000

F I N A L

U A S D	U A S D
UNIBE	7 - 2

BATEO COLECTIVO

		JJ	VB	CA	CE	HS	AVE	H1	H2	H3	HR	BB	ER	K	BA	SLUG
1	UASD	3	83	27	17	29	349	19	9	1	0	8	8	13	40	482
2	UTESA	2	60	11	6	20	333	14	4	1	1	2	0	16	29	483
3	O & M	2	52	12	8	17	326	14	1	1	1	3	2	5	23	442
4	UNPHU	2	51	5	3	11	216	9	1	1	1	5	0	8	17	333
5	UNIBE	3	82	17	15	17	207	10	2	2	3	13	1	21	32	390
6	PUCMM	2	51	7	3	9	176	6	0	2	1	4	0	19	16	313

RECORD LANZADORES COLECTIVO

		JJ	IL	BE	CP	CL	EFFECT.	HS	HR	BB	K	JG	JP	AVE
1	O & M	2	12	80	10	4	2.33	16	0	6	10	1	1	500
2	UNIBE	3	21	90	13	9	3.00	17	0	11	23	2	1	667
3	UNPHU	2	14.1	60	12	8	3.91	12	2	8	18	0	2	000
4	PUCMM	2	14	59	10	9	4.50	14	2	10	7	1	1	500
5	UASD	3	21	95	17	16	5.33	25	3	11	19	3	0	1000
6	UTESA	2	12	69	23	15	8.75	25	1	5	2	0	2	000

	VB	CA	CE	HS	AVE	H1	H2	H3	HR	BB	ER	K	BA	SLUG.
1	Alejandro Soto	1	0	0	1	500	1	0	0	0	0	0	1	1000
2	Julio Mercado	1	0	0	1	1000	1	0	0	0	0	0	1	1000
3	Alejandro de León	5	2	2	3	600	2	0	1	0	0	0	5	1000
4	Edelmiro Colón	7	1	2	4	571	3	10	0	0	0	1	5	714
5	René Peralta	2	2	0	1	500	1	0	0	0	1	0	1	500
6	Edwing Rodríguez	7	1	1	3	428	3	0	0	0	0	1	3	428
7	Alejandro Mateo	3	2	1	1	333	0	0	0	1	1	0	4	1333
8	Dilson Erito	4	1	1	1	250	1	0	0	0	0	0	1	250
9	Domingo Parra	6	2	0	1	167	1	0	0	0	1	1	0	167
10	Ramón Paredes	6	1	1	1	333	0	0	0	1	0	0	4	1333
11	Bony García	1	0	0	0	000	0	0	0	0	0	0	0	000
12	Juan Cruz	1	0	0	0	000	0	0	0	0	0	0	0	000
13	Amaury García	1	0	0	0	000	0	0	0	0	0	0	0	000
14	Gregorio Soto	2	0	0	0	000	0	0	0	0	0	0	0	000
15	Fernando Hernández	5	0	0	0	000	0	0	0	0	0	2	0	000
Totales---		52	12	8	17	326	14	1	1	1	3	2	5	442

Lanzadores

	IL	BE	CP	CL	EFFECT.	HS	HR	BB	K	JG	JP	AVE	
1	Juan Sánchez	6	27	1	0	0.00	6	0	3	8	1	0	1000
2	Henry Muñoz	0.1	5	3	0	0.00	2	0	1	0	0	1	000
3	Leonardo Rosario	5.2	28	6	4	4.95	8	0	2	2	0	0	000
Totales---		12	60	10	4	2.33	16	0	6	10	1	1	500

PONTIFICIA UNIVERSIDAD CATOLICA MADRE Y MAESTRA

	VB	CA	CE	HS	AVE	H1	H2	H3	HR	BB	ER	K	BA	SLUG.
1	Oscaris Alvarado	0	3	0	3	500	3	0	0	0	0	0	3	500
2	Gary Read	6	0	0	2	333	2	0	0	0	0	1	2	333
3	Carlos Gallardo	3	0	0	1	333	0	0	1	0	0	0	3	1000
4	Eduardo Hernández	3	0	1	1	333	0	0	1	0	0	0	3	1000
5	Mayobanex Hernández	4	0	1	1	250	1	0	0	0	2	0	3	250
6	Danny García	6	1	1	1	167	0	0	0	1	0	0	3	667
7	Robinson Sánchez	2	0	0	0	000	0	0	0	0	0	2	0	000
8	Nicolás Martínez	2	1	0	0	000	0	0	0	0	1	0	1	000
9	Leonardo Fajardo	2	0	0	0	000	0	0	0	0	0	2	0	000
10	Eduardo Rincón	2	0	0	0	000	0	0	0	0	0	0	0	000
11	José Guíerrez	3	0	0	0	000	0	0	0	0	0	1	0	000
12	Junior Gómez	3	1	0	0	000	0	0	0	0	0	0	0	000
13	Víctor Ramírez	4	1	0	0	000	0	0	0	0	1	0	2	000
14	Leo Curiel	5	0	0	0	000	0	0	0	0	0	3	0	000
Totales---		51	7	3	9	176	6	0	2	1	4	0	19	313

Lanzadores

	IL	BE	CP	CL	EFFECT.	HS	HR	BB	K	JG	JP	AVE	
1	Eduardo Rincón	7	25	1	1	1.00	6	1	6	0	1	0	1000
2	Leonardo Fajardo	7	34	9	8	8.00	8	1	4	7	0	1	000
Totales		14	59	10	9	4.50	14	2	10	7	1	1	500

UNIVERSIDAD AUTONOMA DE SANTO DOMINGO

	VB	CA	CE	HS	AVE	H1	H2	H3	HR	BB	ER	K	BA	SLUG.
1 Pedro Medrano	9	4	1	5	555	5	0	0	0	4	1	0	5	555
2 Geovanny Almonte	12	3	3	5	417	2	2	1	0	1	3	2	9	750
3 Diógenes Beltres	9	3	3	3	333	1	2	0	0	0	0	2	4	444
4 Sadiel Lorenzo	11	1	4	3	273	3	0	0	0	0	0	1	3	273
5 Manuel Lebrón	12	1	2	3	250	2	1	0	0	0	1	2	4	333
1 Valerio Aquino	1	2	0	1	1000	1	0	0	0	1	0	0	1	1000
2 Newton Mesa	1	1	0	1	1000	1	0	0	0	0	1	0	1	1000
3 Johnny Pérez	5	2	4	4	800	2	2	0	0	0	0	1	6	1200
4 Juan Mones	3	1	0	1	333	1	0	0	0	0	1	1	1	333
5 Johnny Alcántara	3	1	0	1	333	1	0	0	0	0	0	1	1	333
6 Carlos Sánchez	4	2	0	1	250	0	1	0	0	0	0	0	2	500
7 Carlos de los Santos	6	2	0	1	167	0	1	0	0	0	0	3	2	333
8 Melido Tejeda	1	2	0	0	600	0	0	0	0	2	1	0	0	600
9 Fco. Rodríguez	1	0	0	0	600	0	0	0	0	0	0	0	0	600
Totales---	83	27	17	29	349	19	9	1	0	8	8	13	40	482

L a n z a d o r e s

	IL	BE	CP	CL	EFE.	HS	HR	BB	K	JG	JP	AVE
1 Franklin Reynoso	14	58	6	6	3.00	11	2	8	9	2	0	1000
2 Juan Reyes	2.1	11	3	2	6.01	3	0	1	4	0	0	600
3 Víctor Soto	4.2	26	8	8	12.02	11	1	2	6	1	0	1000
Totales---	21	95	17	16	5.33	25	3	11	19	3	0	1000

UNIBERSIDAD IBEROAMERICANA

	VB	CA	CE	HS	AVE	H1	H2	H3	HR	BB	ER	K	BA	SLUG
1 José Rojas	6	3	1	3	500	2	1	0	0	2	0	1	4	667
2 Roberto Cruz	9	2	0	2	222	2	0	0	0	1	0	0	2	222
3 Erick Gutierrez	10	2	0	1	100	1	0	0	0	1	0	2	1	1080
4 Mario López	10	1	2	1	100	0	0	1	0	0	0	0	3	360
1 Amauris Sosa	1	1	0	1	1000	1	0	0	0	0	0	0	1	1000
2 Rafael Grow S.	6	3	1	3	500	2	1	0	0	2	0	1	4	667
3 Alain Natera	2	1	0	1	500	1	0	0	0	1	0	0	1	500
4 Luis L. Pichardo	7	1	9	3	429	1	0	0	2	1	0	2	9	1206
5 Cleder Mota	6	1	0	0	600	0	0	0	0	1	1	2	0	600
6 Ramón Pérez	0	1	0	0	600	0	0	0	0	1	0	0	0	600
7 Rosmel Santana	5	0	0	0	600	0	0	0	0	1	0	2	0	600
8 Pavel Aquino	1	0	0	0	600	0	0	0	0	0	0	1	0	600
9 Arquímedes Ramírez	4	0	0	0	600	0	0	0	0	0	0	3	0	600
10 Jorge Mota	0	0	0	0	600	0	0	0	0	1	0	0	0	600
11 Pascual HENRIquez	0	1	0	0	600	0	0	0	0	1	0	0	0	600
12 Antonio González	3	0	0	0	600	0	0	0	0	1	0	2	0	600
13 Bienvenido Rojas	3	0	0	0	600	0	0	0	0	0	0	2	0	600
14 Francis Félix	3	0	0	0	600	0	0	0	0	0	0	0	0	600
15 Manuel Sánchez	1	0	0	0	600	0	0	0	0	0	0	1	0	600
16 Larry González	2	0	0	0	600	0	0	0	0	0	0	1	0	600
17 Manuel Rodríguez	0	0	0	0	600	0	0	0	0	0	0	0	0	600
Totales---	82	17	15	17	207	10	2	2	3	13	1	21	32	390

L a n z a d o r e s

	IL	BE	CP	CL	EFE.	HS	HR	BB	K	JG	JP	AVE
1 Jorge Mota	7	26	2	1	1.00	4	0	2	8	1	0	1000
2 Manuel Rodríguez	6.9	141	7	6	4.50	7	0	7	5	1	1	500
3 Juan Ramón	4.2	23	4	2	5.26	6	0	2	8	0	0	600
Totales---	21	90	13	9	3.00	17	0	11	23	2	1	667

UNIVERSIDAD NACIONAL PEDRO HENRIQUEZ UREÑA

	VB	CA	CE	HS	AVE	H1	H2	H3	HR	BB	BR	K	PA	SLUG.	
1	Pedro Peña	1	0	0	1000	1	0	0	0	0	0	0	1	1000	
2	Junior Abreu	2	2	0	500	1	0	0	0	2	0	0	1	500	
3	Eduardo Hernández	2	0	0	500	1	0	0	0	0	0	0	1	500	
4	Eduardo Aquino	3	0	0	333	1	0	0	0	0	0	2	1	333	
5	Juan Tejeda	6	2	2	333	1	1	0	1	1	0	1	3	500	
6	Francisco Rosario	6	0	0	333	1	0	1	0	0	0	0	4	667	
7	Rafael Concepción	5	0	0	200	1	0	0	0	0	0	1	1	200	
8	Holguin Brito	2	0	0	000	0	0	0	0	1	0	1	0	000	
9	Rafael Morillo	3	0	0	000	0	0	0	0	0	0	0	0	000	
10	Angel M. Gómez	4	0	0	000	0	0	0	0	0	0	0	0	000	
11	Wilson O. Rodríguez	0	0	0	000	0	0	0	0	0	0	0	0	000	
12	Leonardo Caldera	0	0	0	000	0	0	0	0	0	0	0	0	000	
13	Fernando Graciano	2	0	0	000	0	0	0	0	0	0	1	0	000	
14	Norberto Erock	3	0	0	000	0	0	0	0	0	0	1	0	000	
15	Pedro Rosario	7	1	1	286	2	0	0	0	0	0	0	2	286	
16	Miguel Paulino	5	0	0	000	0	0	0	0	1	0	1	0	000	
17	William Orozco	0	0	0	000	0	0	0	0	0	0	0	0	000	
	Totales---	51	5	3	11	216	9	1	1	1	5	0	8	17	333

L a n z a d o r e s

	IL	BE	CP	CL	EFFECT.	HS	HR	BB	K	JG	JP	AVE	
1	Wilson O. Rodríguez	7	29	3	2	2.00	5	0	4	8	0	0	000
2	William Orozco	7	26	5	2	2.00	5	1	2	9	0	1	000
3	Pedro Peña	0.1	5	4	4	84.85	2	1	1	1	0	1	000
	Totales---	14.1	60	12	8	3.82	12	2	8	18	0	2	000

UNIVERSIDAD TECNOLÓGICA DE SANTIAGO

	VB	CA	CE	HS	AVE	H1	H2	H3	HR	BB	BR	K	PA	SLUG.	
1	Ricardo Parra	1	0	0	1000	0	1	0	0	0	0	0	2	2000	
2	René Durán	2	0	0	500	1	0	0	0	0	0	0	1	500	
3	Víctor Almonte	7	2	0	429	3	0	0	0	0	0	1	3	429	
4	Alejandro Manzueta	7	1	2	429	2	0	0	1	0	0	1	6	857	
5	Juan Aybar	5	0	2	400	0	2	0	0	2	0	0	4	800	
6	Diómedes Durán	3	2	0	333	1	0	0	0	0	0	2	1	333	
7	Ramón Estevez	7	2	1	286	1	0	1	0	0	0	1	4	571	
8	Héctor Andrés	7	1	0	286	2	0	0	0	0	0	3	2	286	
9	Luis Valera	7	1	0	286	1	1	0	0	0	0	1	3	429	
10	Lonny Reyes	7	1	1	286	2	0	0	0	0	0	2	2	286	
11	José Gómez	6	1	0	167	1	0	0	0	0	0	4	1	167	
12	José Valenzuela	1	0	0	000	0	0	0	0	0	0	1	0	000	
	Totales---	60	11	6	20	333	14	4	1	1	2	0	16	29	483

L a n z a d o r e s

	IL	BE	CP	CL	EFFECT.	HS	HR	BB	K	JG	JP	AVE	
1	Francisco Piñeyro	3	13	3	1	2.33	4	0	0	0	0	000	
2	Richard Santos	1	5	2	1	7.00	2	0	0	0	0	000	
3	Jerson Placencio	2.0	13	4	4	14.00	4	0	2	1	0	1	000
4	Carlos Valdéz	1	10	6	6	42.00	5	0	0	0	0	0	000
5	José Acevedo	5	28	8	3	4.20	10	1	3	1	0	1	000
	Totales---	12	69	23	15	8.75	25	1	5	2	0	2	000

F U T B O L

En el torneo de futbol de la III Universiada, al igual que el baloncesto femenino, solo participaron dos Instituciones.

El equipo de la UASD resultó ganador dos goles por uno en partido que la UNPHU comenzó con solo ocho jugadores.

La nómina de los equipos fue la siguiente:

<u>U N P H U</u>	<u>U A S D</u>
1 Leopoldo Deivi	1 Luciano Ramirez
2 Ramón Rijo	2 Carlos Merdn
3 Humberto Tavarez	3 Luis Ramirez
4 Rubén Tavarez	4 Angel Brito
5 Dinaldo Rodriguez	5 Aristofany Arias
6 Bolívar Pérez	6 Winston Ramirez
7 Emilio D'Achille	7 Juan Pérez Gómez
8 Feliciano Morel	8 Felix Adames
9 Euclides Castillo	9 Carlos Torres
10 Carlos Alb. Ramirez	10 Mariano de León
11 Adler Rosario	11 Carlos Martes
12 Francisco Martínez	12 Eugenio Adames
13 Fernando Nájera	13 Ney Díaz
14 Antonio Rosa	14 Juan Ramirez
	15 Antonio Francisco
	16 Freddy de Jesús

R e s u l t a d o s

1	UASD	2 - 1
2	UNPHU	1 - 2

JUDO

La competencia de JUDO de la III Universiada Nacional fue una de la más representativa a nivel universitario que se han celebrado.

Siete Universidades y 54 competidores se dieron cita el domingo 22 de marzo en la Escuela Nacional de Judo ubicada en el pabellón de Voleibol del centro olimpico Juan Pablo Duarte.

La UNPHU, que tradicionalmente ha dominado esta disciplina ganó la rama masculina. La O&M dio la sorpresa al triunfar en la rama femenina.

El cuadro de medallas y puntuación final fue el siguiente:

<u>Masculino</u>						<u>Femenino</u>					
	<u>O</u>	<u>P</u>	<u>E</u>	<u>T</u>	<u>PTOS.</u>		<u>O</u>	<u>P</u>	<u>E</u>	<u>T</u>	<u>PTOS.</u>
1 UNPHU	4	3	1	8	30	1 O & M	4	2	1	7	27
2 PUCMM	3	3	1	7	25	2 UNPHU	2	2	4	8	20
3 O & M	0	1	7	8	10	3 UASD	0	1	2	3	5
4 UNIBE	1	0	0	1	5	4 PUCMM	0	1	0	1	3
5 UTESA	0	1	1	2	4						
6 UASD	0	0	1	1	1						
7 UCE	0	0	1	1	1						

NOMINA DE PARTICIPANTES EN J U D O

38

U N P H U

- 1 Luis Vizcaíno
- 2 Roberto de León
- 3 Andrés de León
- 4 Eker Raposo
- 5 Livio Valdéz
- 6 Porfirio Méndez
- 7 Marcos Almanzar
- 8 Angel Carrasco
- 9 Ana Lidia Salcedo
- 10 Rosa Hidalgo
- 11 Geovanny Marte
- 12 Ofelicia Olivares
- 13 Sunilda Ramírez
- 14 Rosa Galán
- 15 Evelin Castillo
- 16 Juana Sosa

O & M

- 1 Guillermo Sánchez
- 2 Héctor Díaz
- 3 Julio Ruiz
- 4 Dioni Isaac
- 5 Jorge Brito
- 6 Ignacio Cruz
- 7 Claudio Espinosa
- 8 Francisco Tapia
- 9 Rosa Lenny Castillo
- 10 Marlene Sánchez
- 11 Virtudes Borges
- 12 Bartola Devers
- 13 Dorka Moreno
- 14 Celeste Díaz
- 15 Eleocadia Vargas

U T E S A

- 1 Julio Nájuez
- 2 Rafael Estevez
- 3 Manuel Terrero

U N I B E

- 1 Cyamau Schaldu

U A S D

- 1 Rafael Mateo
- 2 Pedro de la Cruz
- 3 Luis Peña
- 4 Angel Binet
- 5 Vicente Silvestre
- 6 Manuel Herrera
- 7 Francisca Mojica
- 8 Rosa M. Castro
- 9 Felicia Briu

P U C M M

- 1 Roberto de los Santos
- 2 Víctor Mateo
- 3 Gilberto García
- 4 José Alevante
- 5 Domingo Batista
- 6 Jesús Arzeno
- 7 José Estrella
- 8 José Ledesma
- 9 Damary Hodge

U C E

- 1 Arquímedes Ortiz

CUADRO DE PARTICIPACION

		<u>H</u>	<u>M</u>	<u>Total</u>
1	UNPHU	8	8	16
2	O & M	8	7	15
3	PUCMM	8	1	9
4	UASD	6	3	9
5	UTESA	3	0	3
6	U C E	1	0	1
7	UNIBE	1	0	1
		<u>35</u>	<u>19</u>	<u>54</u>

RESULTADOS J U D O MASCULINO

CAT. 56 KG.

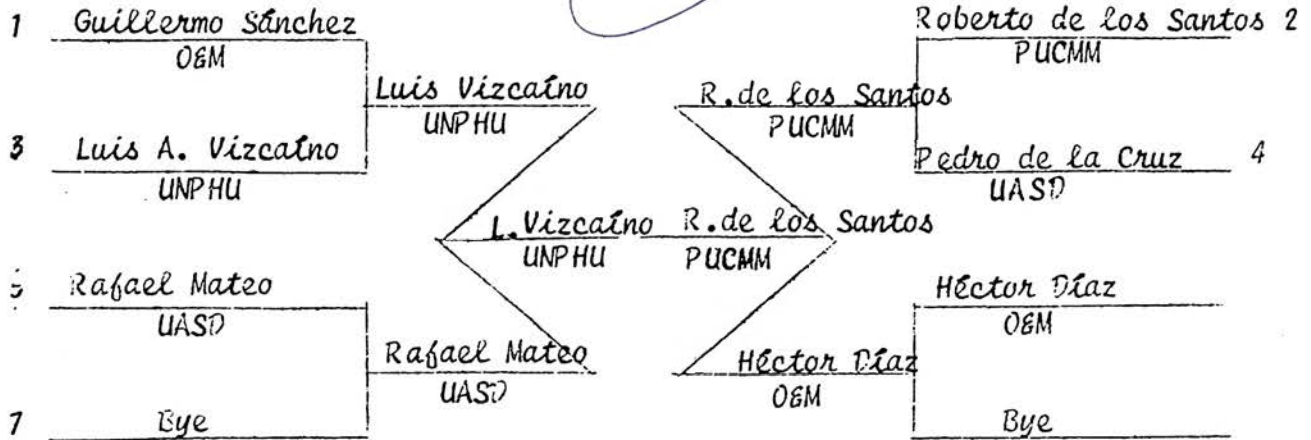

Repechage

Guillermo Sánchez
O&M
Rafael Mateo
UASD

1 Luis Vizcaíno UNPHU
2 Roberto de los Santos PUCMM
3 Guillermo Sánchez O&M
3 Héctor Díaz O&M
G. Sánchez O&M
Héctor Díaz O&M

Repechage

Pedro de la Cruz
UASD
Héctor Díaz
O&M

60 Kg

			1	2	3	PUNTOS
1	Víctor J. Mateo	PUCMM		10	10	
2	Roberto de León	UNPHU	0		10	
3	Julio Ruiz	O&M	0	0		

65 Kg

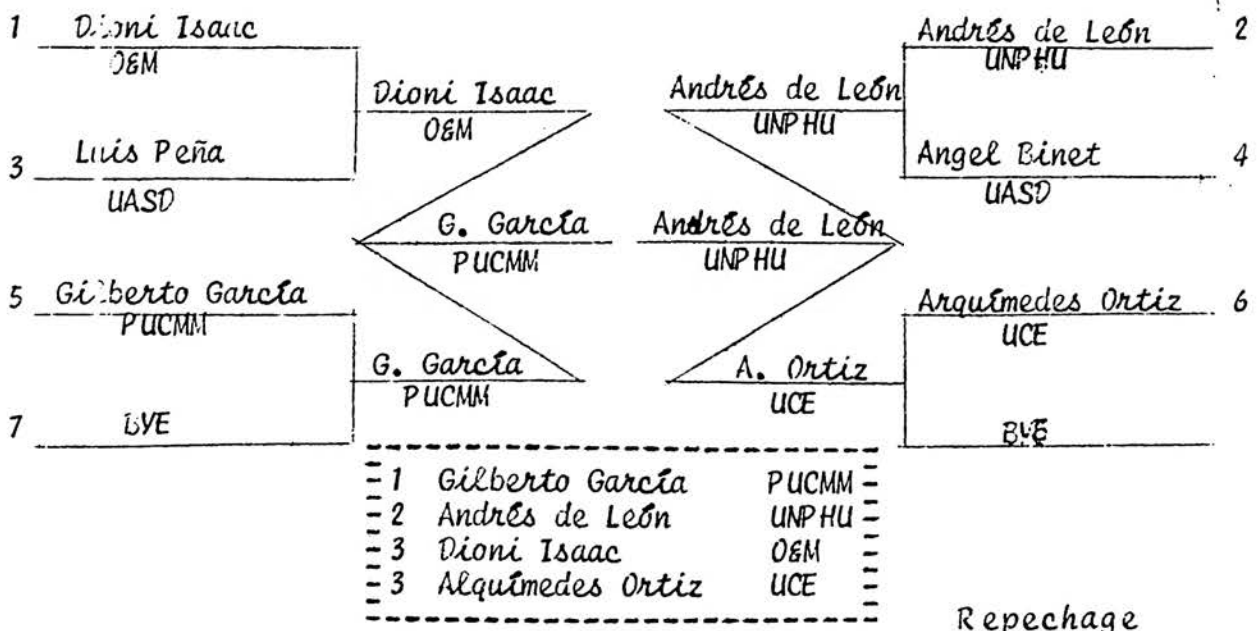

Repechage

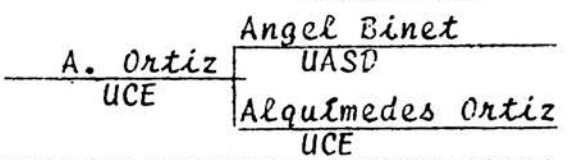

71 Kg.

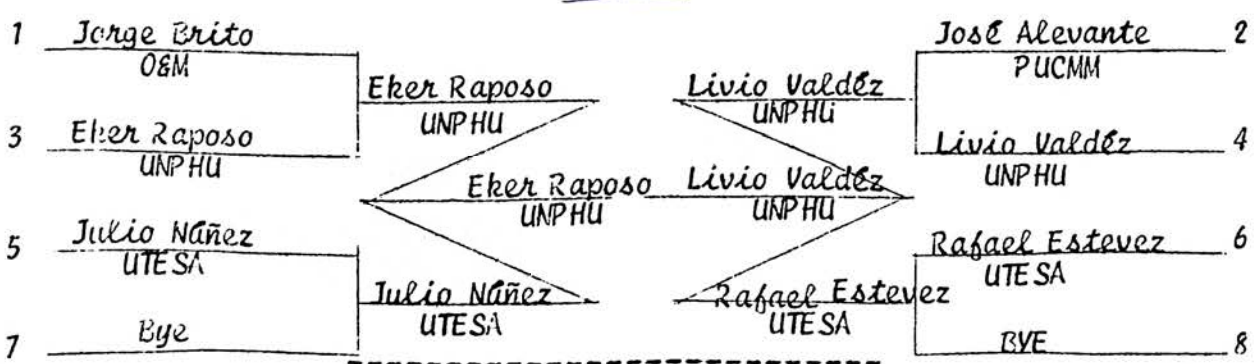

- | | | |
|---|----------------|-------|
| 1 | EKER RAPOSO | UNPHU |
| 2 | Livio Valdéz | UNPHU |
| 3 | Jorge Brito | O&M |
| 3 | Rafael Estevez | UTESA |

Repechage

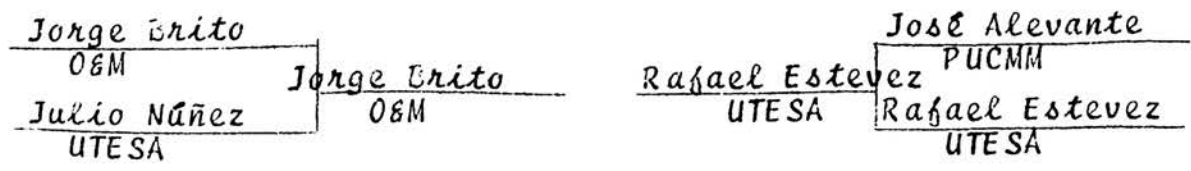

78 Kg.

1	Ignacio Cruz O&M			BYE	2
3	Manuel Terrero UTESA	ML. Terrero UTESA		Manuel Herrera UASD	4
5	Vicente Silvestre UASD	ML. Terrero UTESA	Porfirio Méndez UNPHU	Porfirio Méndez UNPHU	6
7	BYE	V. Silvestre UASD	P. Méndez UNPHU	BYE	8

1	PORFIRIO MENDEZ	UNPHU
2	Manuel Terrero	UTESA
3	IGNACIO Cruz	O&M
3	Manuel Herrera	UASD

Repechage

Ignacio Cruz O&M	Ignacio Cruz O&M
Vicente Silvestre UASD	

86 Kg.

			1	2	PUNTOS
1	Domingo Batista	PUCMM		10	
2	Claudio Espinosa	O&M	0		

95 Kg.

			1	2	3	PUNTOS
1	Marcos Almanzar	UNPHU		10	10	
2	Jesús Arzeno	PUCMM	0		10	
3	Francisco Tapia	O&M	0	0		

+95 Kg.

			1	2	3	4	PUNTOS
1	Cyamau Schaldu	UNICE		10	10	10	
2	José Ledesma	PUCMM	0		7	10	
3	Angel Carrasco	UNPHU	0	0		10	
4	José Estrella	PUCMM	0	0	0		

RESULTADOS J U D O FEMENINO

42

CAT. 45 KG.

			1	2	PUNTOS
1	ANA LIDIA SALCEDO	UNPHU		5	5
2	DAMARY HODGE	PUCMM	0		0

CAT. 48 KG.

			1	2	PUNTOS
1	ROSA HIDALGO	UNPHU		10	10
2	ROSA LENNY CASTILLO	O&M	0		0

CAT. 52 KG.

			1	2	3	4	PUNTOS
1	MARLENE SANCHEZ	O&M		10	10	10	30
2	VIR TUDES BORGES	O&M	0		10	10	20
3	FRANCISCA MOJICA	UASD	0	0		10	10
4	ROSA M. CASTILLO	UASD	0	0	0		0

CAT. 56 KG.

			1	2	3	4	PUNTOS
1	KARTOLA DEVERS	O&M		10	10	10	30
2	OFELIA OLIVARES	UNPHU	0		10	10	20
3	DORKA MORENO	O&M	0	0		10	10
4	GEOVANNY MARTE	UNPHU	0	0	0		0

CAT. 61 KG.

43

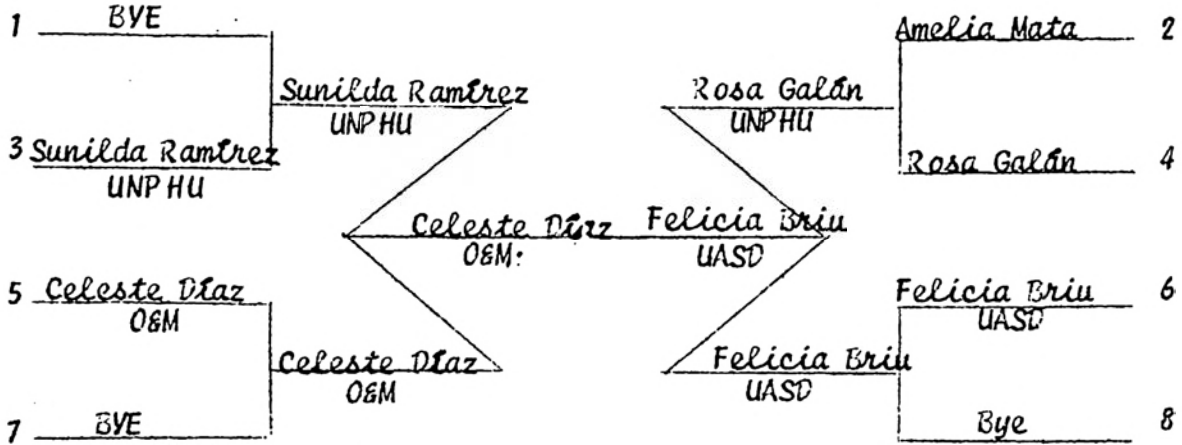

1	CELESTE DIAZ	O&M
2	FELICIA BRIU	UASD
3	SUNILDA RAMIREZ	UNPHU
3	ROSA GALAN	UNPHU

CAT. 66 KG.

			1	2	3	PUNTOS
1	ELEOCADIA VARGAS	O&M		10	10	20
2	EVELIN CASTILLO	UNPHU	0		10	10
3	JUANA SOSA	UNPHU	0	0		0

RELACION DE MEDALLAS DE JUDO POR CATEGORIA

			ORO	PLATA	BRONCE
1	56 Kg.	M	UNPHU	PUCMM	O&M O&M
2	60 Kg.	M	PUCMM	UNPHU	O&M
3	65 Kg.	M	PUCMM	UNPHU	O&M UCE
4	71 Kg.	M	UNPHU	UNPHU	O&M UTESA
5	78 Kg.	M	UNPHU	UTESA	UASD O&M
6	86 Kg.	M	PUCMM	O&M	-
7	95 Kg.	M	UNPHU	PUCMM	O&M
8	+95 Kg.	M	UNIBE	PUCMM	PUCMM UNPHU
1	45 Kg.	F	UNPHU	PUCMM	-
2	48 Kg.	F	UNPHU	O&M	-
3	52 Kg.	F	O&M	O&M	UASD UASD
4	56 Kg.	F	O&M	UNPHU	O&M UNPHU
5	61 Kg.	F	O&M	UASD	UNPHU UNPHU
6	66 Kg.	F	O&M	UNPHU	UNPHU

CUADRO DE MEDALLAS Y PUNTUACION GENERAL

		<u>O</u>	<u>P</u>	<u>B</u>	<u>T</u>	<u>PTOS.</u>
1	UNPHU	6	5	5	16	50
2	O&M	4	3	8	15	37
3	PUCMM	3	4	1	8	28
4	UASD	0	1	3	4	6
5	UNIBE	1	0	0	1	5
6	UTESA	0	1	1	2	4
7	UCE	0	0	1	1	1

KARATE

La competencia de KARATE de la III Universiada Nacional fué bien representativa con la participación de siete Universidades que se dieron cita en el pabellón techado del Club San Lázaro.

El evento tuvo un nivel técnico muy elevado.

La única nota negativa fué la participación de varios competidores NO ESTUDIANTES, principalmente de UNAPEC, que posteriormente fueron descalificados. Esperamos que en el futuro las Instituciones solo participen con los estudiantes-atletas que tengan, sin buscar atletas de la calle.

POSICION FINAL POR EQUIPO Y CUADRO DE MEDALLAS

		<u>O</u>	<u>P</u>	<u>G</u>	<u>T</u>
1	U A S D	3	2	3	8
2	U T E S A	1	3	0	4
3	P U C M M	2	5	3	10
4	O & M	5	3	2	10
5	U N P H U	2	0	3	5
6	C D E P	0	0	1	1
7	UNAPEC	0	0	0	0

NOMINA DE PARTICIPANTES KARATE

U N P H U

- 1 Robert Sánchez
- 2 Angel S. Carrasco
- 3 Fabian Fernández
- 4 Leonardo Baldera
- 5 Miguel Delgado
- 6 Ramón Tapia
- 7 Xenia Olivier
- 8 Francelina Camacho

P U C M M

- 1 Elio Fernández
- 2 Eugenio Vasquez
- 3 Germán Reyes
- 4 Patria Paulino
- 5 Ingrid Bernabé
- 6 Ramona Arias
- 7 Manuel Jaquez
- 8 Eduardo Núñez

U A S D

- 1 José Rosario
- 2 Ramón Mota
- 3 Odalis Rivera
- 4 Nicolás Nájiz
- 5 Guillermo Pezotti
- 6 William Duarte
- 7 Eekhis Ledesma
- 8 María Félix;
- 9 Adalgisa Rivera
- 10 Antonio Tejada

U T E S A

- 1 Daniel Quiñones
- 2 Franklin Brotini
- 3 Humberto Cuevas
- 4 Robert Alcántara
- 5 Orlando Flores
- 6 Adenawell Alvarez
- 7 Marilyn Castillo

O E M

- 1 Julio Marte
- 2 Wilkleng Paula
- 3 Antonio Paulino
- 4 Andrés Paulino
- 5 Rafael Cuevas
- 6 Ramón Bello
- 7 Luis Turbit
- 8 Octavio Betoven
- 9 Maribel Orsini
- 10 Edita Mañón
- 11 Ivelise Ledesma

U N A F E C

- 1 Santiago Castro
- 2 Pablo Mota
- 3 Miguel Brito

C D E P

- 1 María Florian
- 2 Jenao Lorenzo
- 3 Carlos Peña
- 4 Samuel Villamán

KATA MASCULINA

1	Angel S. Carrasco	UNPHU
2	Julio Marte	OEM
3	Elio Hernández	PUCMM

KATA FEMENINA

1	Xenia Olivier	UNPHU
2	Maribel Orsini	OEM
3	INGRID Bernabé	PUCMM

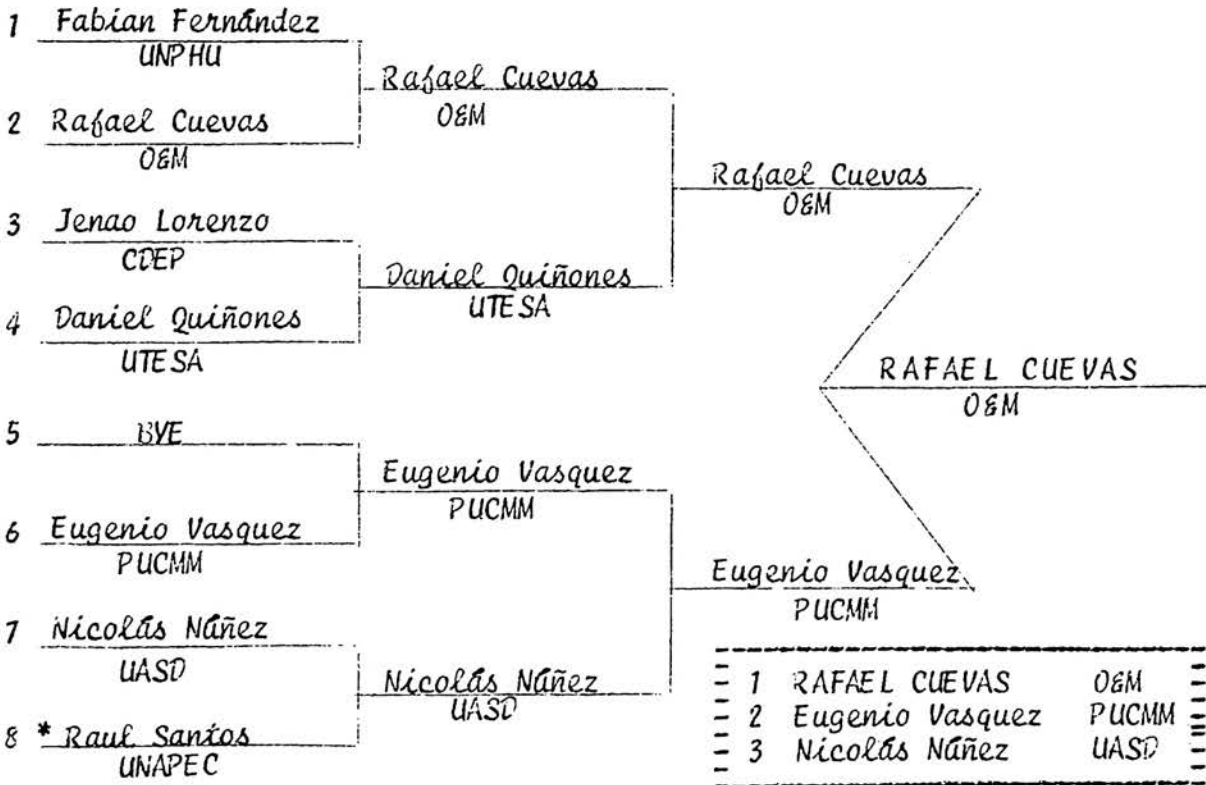

2do. P E S O

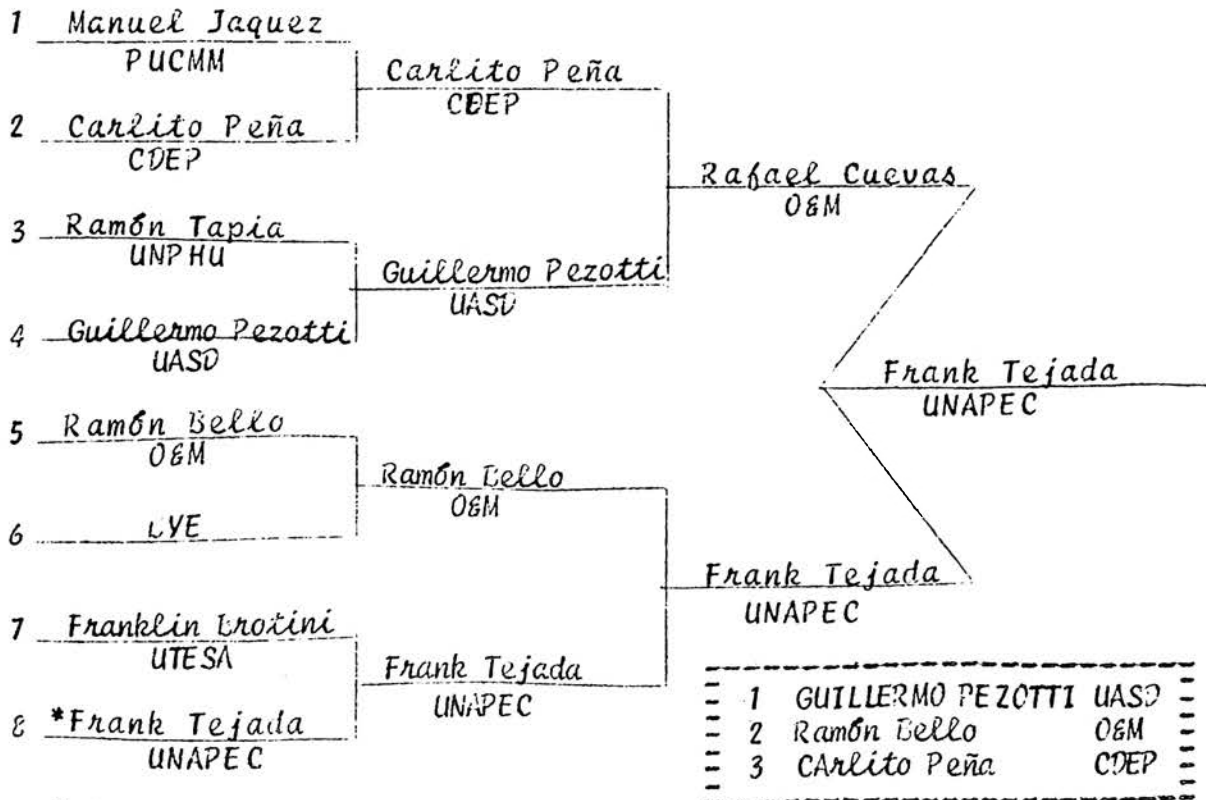

* NO ESTUDIANTES

3er. P E S O

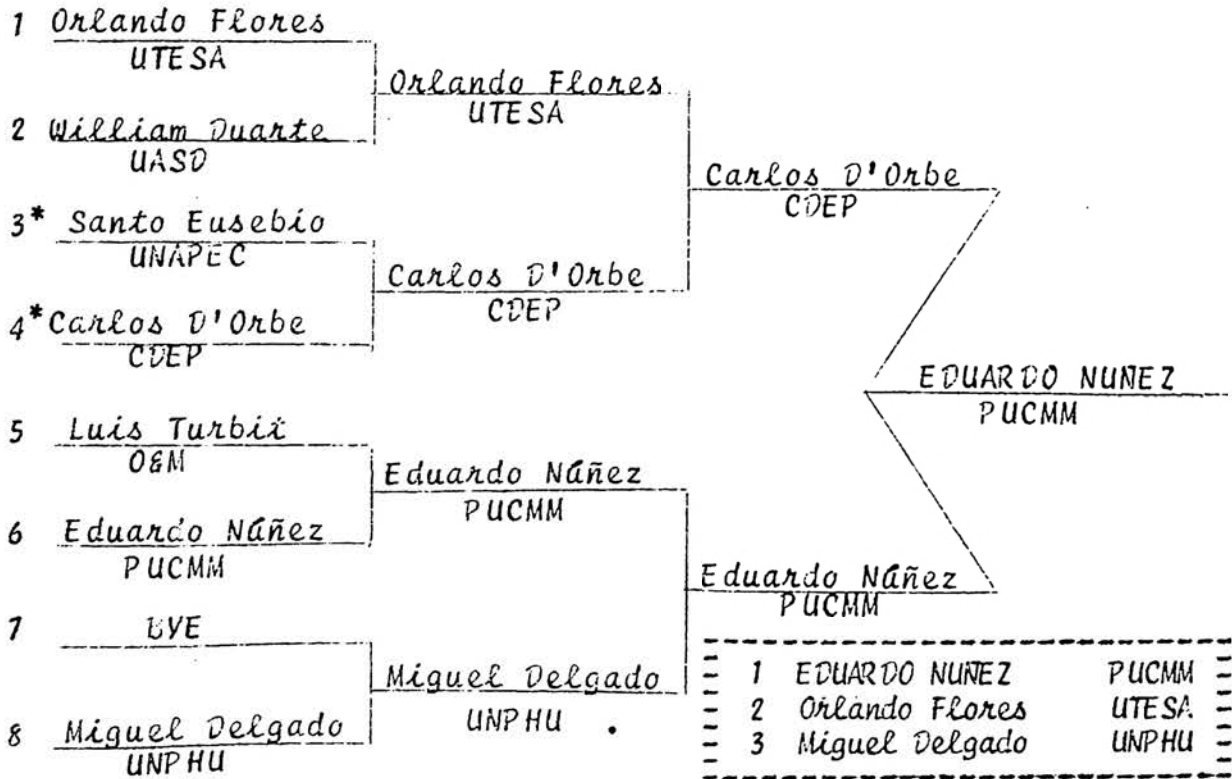

* NO ESTUDIANTES

4to. P E S O

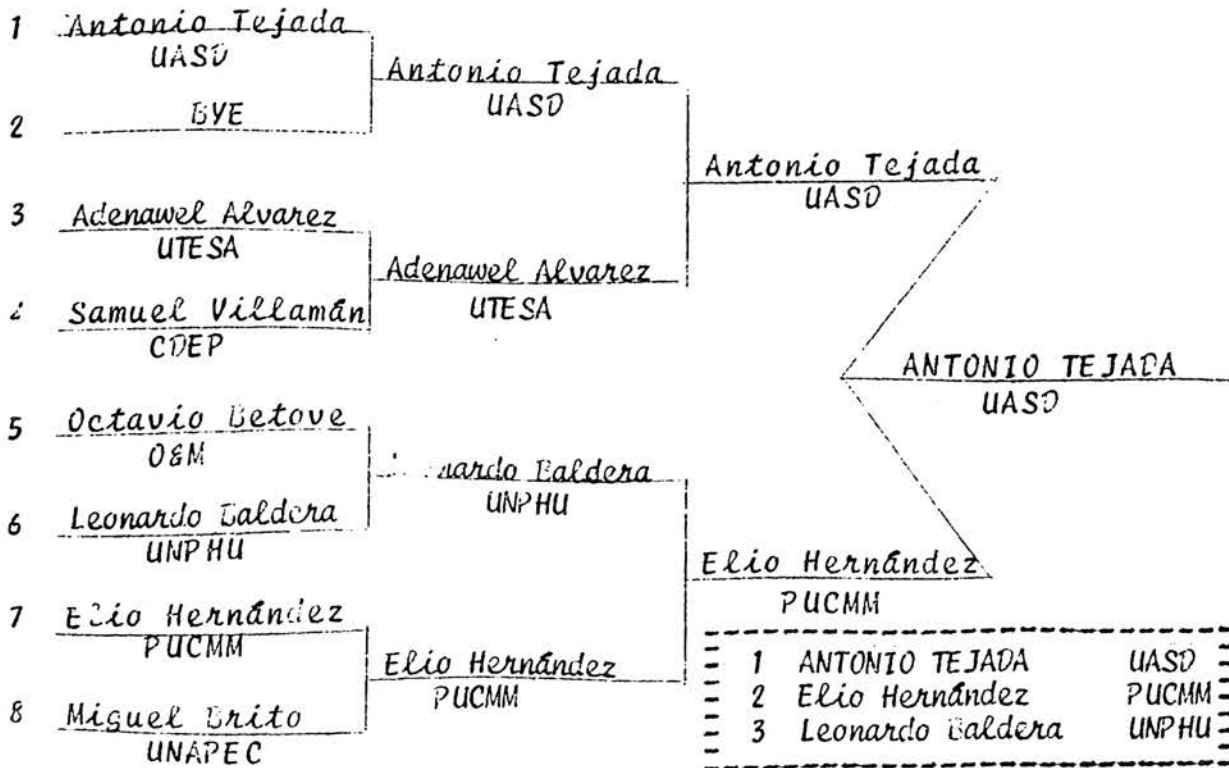

5to. P E S O

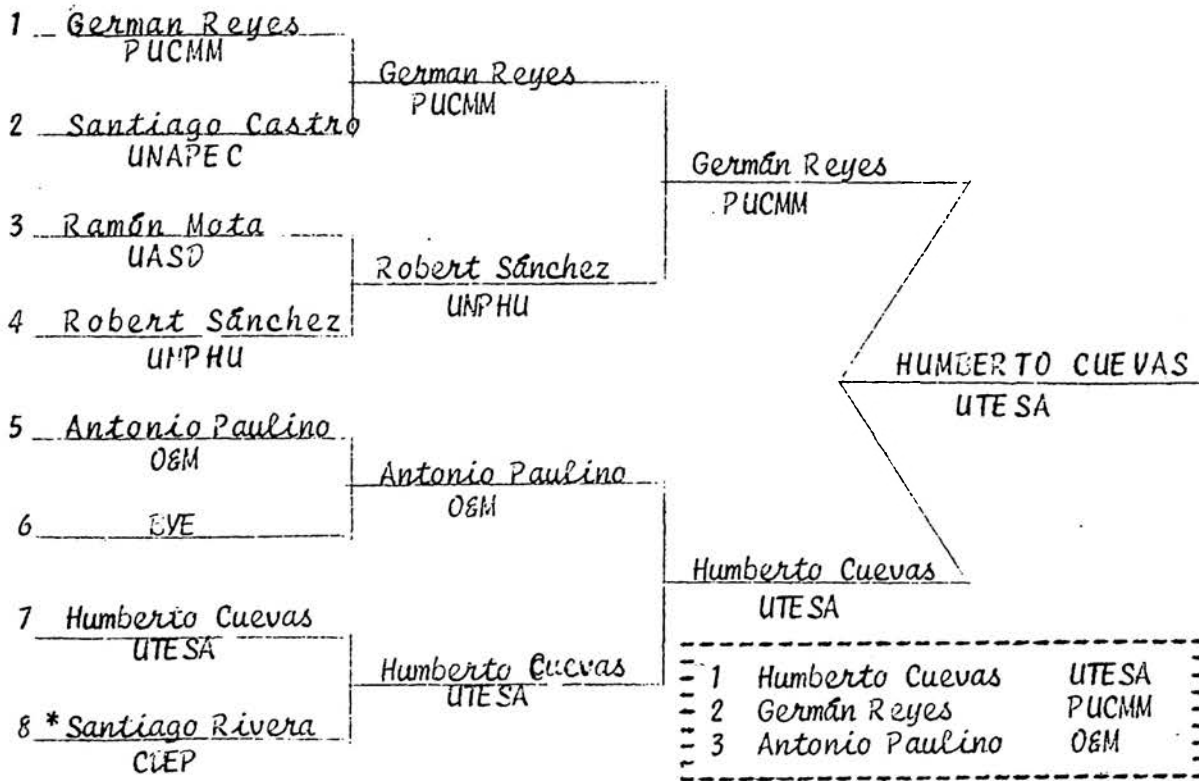

6to. P E S O

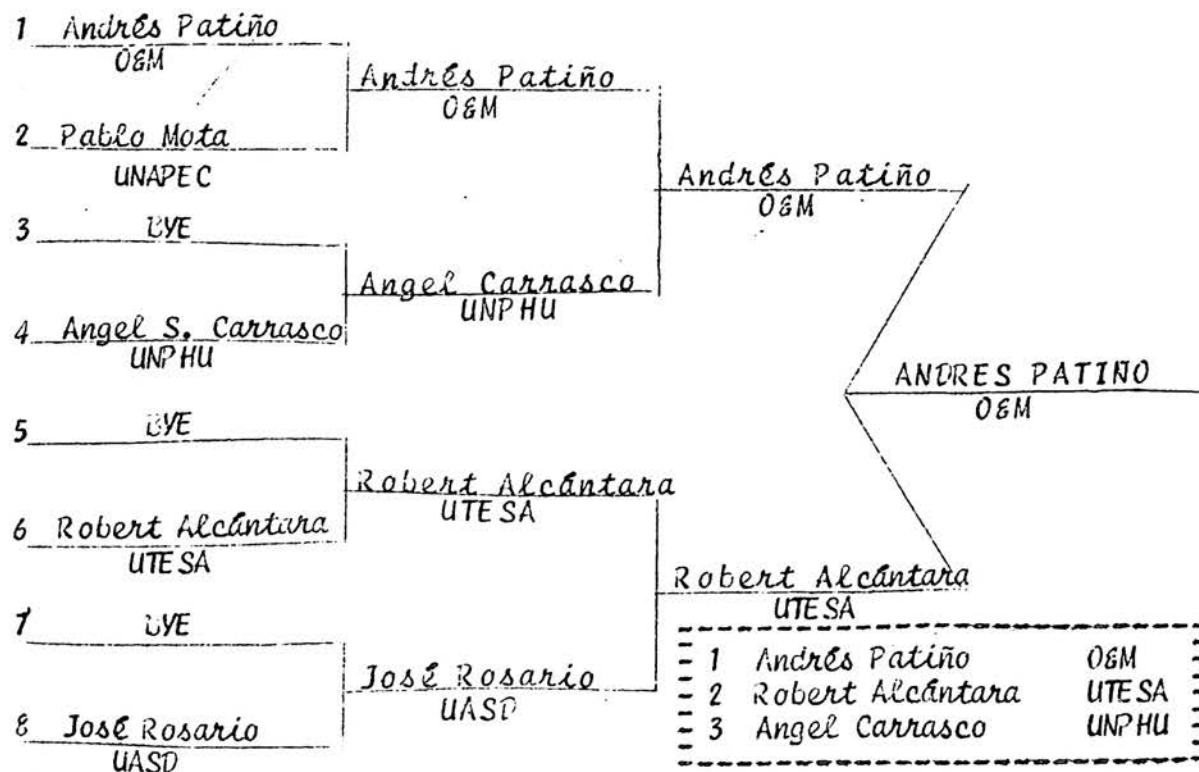

F E M E N I N O

1ER. P E S O

1	<u>María Paulino</u> PUCMM		María Paulino PUCMM		María Paulino PUCMM	}	<u>MARIBEL ORSINI</u> O&M
2	<u>Francelina Camacho</u> UNPHU		3		<u>Marilín Castillo</u> UTESA		
					5	<u>María Félix</u> UASD	
							1 Maribel Orsini O&M
							2 María Paulino PUCMM
							3 María Félix UASD

2DO. P E S O

1	<u>Edita Mañón</u> O&M		EDITA MAÑON O&M	}	1 Edita Mañón O&M
2	<u>Adalgisa Rivera</u> UASD		2		<u>Adalgisa Rivera</u> UASD

3ER. P E S O

1	<u>Ramona Arias</u> PUCMM		Elka Rodriguez UNAPEC		Elka Rodriguez UNAPEC	}	1 Ivelise Ledesma O&M
2	<u>*Elka Rodriguez</u> UNAPEC		3		<u>Ivelise Ledesma</u> O&M		
							2 Ramona Arias PUCMM
							3 Elkis Ledesma UASD

* NO ESTUDIANTE

EQUIPO MASCULINO

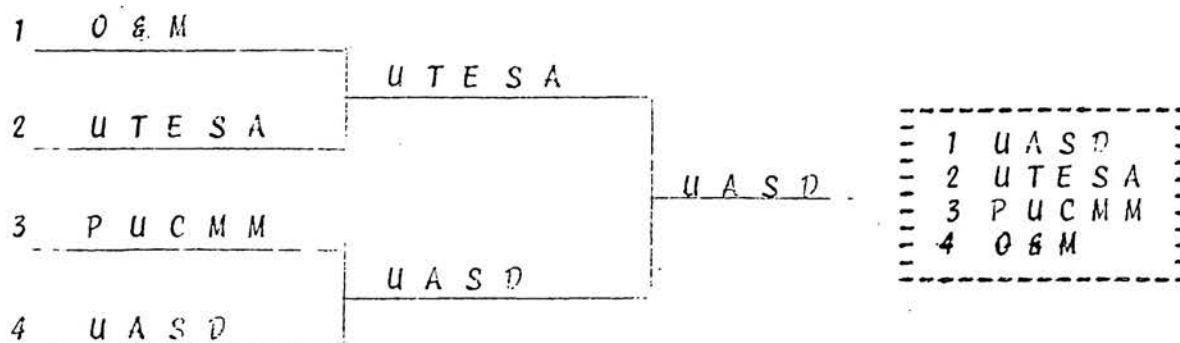

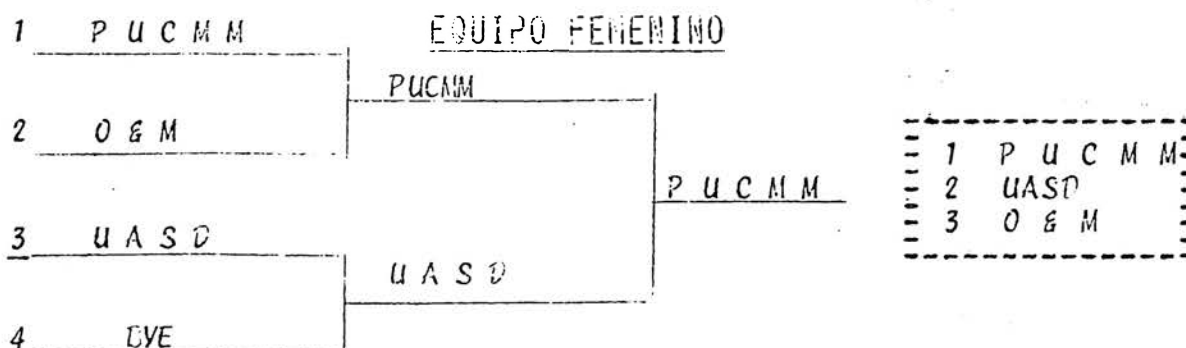

CUADRO DE MEDALLAS POR CATEGORIA

				O R O	P L A T A	B R O N C E
1	1er. Peso	M	M	O & M	PUCMM	UASD
2	2do. Peso		M	UASD	O&M	CDEP
3	3er. Peso		M	PUCMM	UTESA	UNPHU
4	4to. Peso		M	UASD	PUCMM	UNPHU
5	5to. Peso		M	UTESA	PUCMM	O&M
6	6to. Peso		M	O&M	UTESA	UNPHU
7	1er. Peso		F	O & M	PUCMM	UASD
8	2do. Peso		F	O & M	UASD	-
9	3er. Peso		F	O & M	PUCMM	UASD
10	EQUIPO		M	UASD	UTESA	PUCMM
11	EQUIPO		F	PUCMM	UASD	O & M
12	K A T A		M	UNPHU	O & M	PUCMM
13	K A T A		F	UNPHU	O & M	PUCMM

NATACION

La natación volvió nuevamente a la Universiada despues de la pausa de la anterior. Una lucida competencia se efectuó en la piscina olímpica del centro olímpico Juan Pablo Puarte el sábado 21 de marzo.

Nuevamente los nadadores de la UNPHU coparon los máximos honores.

Heriberto Jiménez, de UNAPEC y Glorivalba Pérez, de la UNPHU, fueron los nadadores más destacados al ganar un gran número de medallas cada uno.

La posición de los equipos y relación de medallas fué el siguiente:

<u>Masculino</u>					<u>Femenino</u>						
		<u>O</u>	<u>P</u>	<u>B</u>	<u>T</u>			<u>O</u>	<u>P</u>	<u>B</u>	<u>T</u>
1	UNPHU	6	7	6	19	1	UNPHU	10	8	5	23
2	UNAPEC	4	1	3	8	2	UNAPEC	0	0	1	1
3	O & M	1	3	1	5	3	O & M	0	0	0	0
4	CIEP	0	0	0	0						

NOMINA DE PARTICIPANTES EN NATACIONU N P H U

- 1 Luis Luege
- 2 Alexis Brugal
- 3 Eddy Hurtado
- 4 Ricardo Martínez
- 5 Lawrence Bertrand
- 6 Wilhem Geldes
- 7 Miguel Valdéz
- 8 Gloríalba Pérez
- 9 Martha Vargas
- 10 Cynthia Aranda
- 11 Xiomara Jaquez
- 12 Patricia D'Oléo
- 13 Evelyn Vasquez

O & M

- 1 Edgardo Rodríguez
- 2 Gerónimo Quelis
- 3 Gustavo Moquete
- 4 Julio Martínez
- 5 Miguel Valdéz
- 6 Roberto Gómez
- 7 Pedro A. Monegro
- 8 Claudio Peña
- 9 Eduardo Espinal
- 10 Ramón Ruiz
- 11 Juana Castillo
- 12 Cristina Encarnación
- 13 Yanet Marte Colón

U N A P E C

- 1 Heriberto Jiménez
- 2 Saulo Reyes
- 3 Luis Heredia
- 4 Marcelo Marte
- 5 Pedro Heyaíme
- 6 Harold Ortiz
- 7 Alan Guerrero
- 8 Wendy Guzmán
- 9 Damayra López

C D E P

- 1 Carlos Vargas
- 2 Jorge A. Tapía
- 3 Luis L. Lugo
- 4 Parra Padilla
- 5 Edwin Díaz
- 6 Luis Peña

Cuadro de Participación

	V	H	TOTAL
1 UNPHU	7	6	13
2 O & M	9	3	12
3 UNAPEC	7	2	9
4 CDEP	6	-	6
	29	11	40

RESULTADOS NATACION

54

Evento N° 1	<u>50 Mts. Libre</u>		<u>Fem.</u>
1	Glorialba Pérez	UNPHU	34.42
2	Patricia D'Oleo	UNPHU	40.44
3	Wendy Guzmán	UNAPEC	43.97
4	Damayra López	UNAPEC	47.59
5	Juana Castillo	O&M	50.73
6	Martha Vargas	UNPHU	51.10
7	Cristina Encarnación	O&M	1.00.81
8	Yanet Marte Colón	O&M	1.06.83

Evento N° 2	<u>50 Mts. Libre</u>		<u>Masc.</u>
1	Heriberto Jiménez	UNAPEC	27.60
2	Luis Luege	UNPHU	29.04
3	Edgardo Rodríguez	O&M	30.05
4	Alexis Brugal	UNPHU	30.39
5	Saulo Reyes	UNAPEC	34.15
6	Carlos Vargas	CDEP	34.23
7	Jorge A. Tapia	CDEP	35.80
8	Gerónimo Quelis	O&M	37.81
9	Luis L. Lugo	CDEP	41.39
10	Gustavo A. Moquete	O&M	45.69
11	Luis Heredia	UNAPEC	45.85
12	Eddy Huriado	UNPHU	1.10.05

Evento N° 3	<u>100 Mts. DORSO</u>		<u>Fem.</u>
1	Glorialba Pérez	UNPHU	1.35.82
2	Cynthia Aranda	UNPHU	2.13.01
3	Patricia D'Oleo	UNPHU	2.30.06
4	Cristina Encarnación	O&M	Abandonó

Evento N° 4	<u>100 Mts. DORSO</u>		<u>Masc.</u>
1	Heriberto Jiménez	UNAPEC	1.16.08
2	Luis Luege	UNPHU	1.20.25
3	Ricardo Martínez	UNPHU	1.23.20
4	Alexis Brugal	UNPHU	1.38.99
5	Parra Padilla	CDEP	1.47.92
6	Marcelo Marte	UNAPEC	No se tiró
7	Julio Martínez	O&M	Descalif.

Evento N° 5	<u>50 Mts. PECHO</u>		<u>Fem.</u>
1	Xiomara Jaquez	UNPHU	46.95
2	Cynthia Aranda	UNPHU	55.15
3	Evelyn Vasquez	UNPHU	1.03.45
	Wendy Guzmán	UNAPEC	Retirada

Evento Nº 6

50 Mts. PECHOMasc.

55

1	Miguel Valdéz	O&M	37.29
2	Ricardo Martínez	UNPHU	38.06
3q	Lawrence Bertrand	UNPHU	38.64
4	Luis Luege	UNPHU	41.42
5	Roberto Gómez	O&M	43.89
6	Saulo Reyes	UNAPEC	46.05
7	Jorge A. Tapia	CDEP	46.75
8	Julio Martínez	O&M	47.05
9	Pedro Heyrime	UNAPEC	48.84
10	Luis Lugo	CDEP	55.40
11	Edwin Díaz	CDEP	1.41.28

Evento Nº 7

100 Mts. LIEREFem.

1	Glorialba Pérez	UNPHU	1.27.51
2	Cynthia Aranda	UNPHU	1.43.97
3	Xiomara Jaquez	UNPHU	1.49.69
4	Damayra López	UNAPEC	1.59.25

Evento Nº 8

100 Mts. LIBREMasc.

1	Heriberto Jiménez	UNAPEC	1.05.03
2	Lawrence Bertrand	UNPHU	1.08.08
3	Ricardo Martínez	UNPHU	1.15.91
4	Pedro A. Monegro	O&M	1.20.58
5	Alexis Brugal	UNPHU	1.26'22
6	Roberto Gómez	O&M	1.28.57
7	Harol Ortiz	UNAPEC	1.39.43
8	Claudio Peña	O&M	1.45.83
9	Parra Padilla	CDEP	1.46.11
10	Luis Peña	CDEP	1.54.56
11	Luis Lugo	CDEP	2.09.50

Evento Nº 9

50 Mts. MARIPOSAFem.

1	Glorialba Pérez	UNPHU	45.85
2	Cynthia Aranda	UNPHU	57.62
3	Patricia D'Oleo	UNPHU	1.10.07

Evento Nº 10

50 Mts. MARIPOSAMasc.

1	Luis Luege	UNPHU	29.49
2	Lawrence Bertrand	UNPHU	29.91
3	Heriberto Jiménez	UNAPEC	30.40
4	Edgardo Rodríguez	O&M	32.84
5	Miguel Valdéz	O&M	35.48
6	Alexis Brugal	UNPHU	45.80
7	Carlos Vargas	CDEP	48.77

Evento Nº 11

RELEVO 4 x 50 COMBINADOFem.

1	Patricia D'Oleo Xiomara Jaquez Glorialba Pérez Martha Vargas	UNPHU	3.30.89
---	---	-------	---------

Evento N° 12

RELEVO 4 x 50 MTS. COMBINADOMasc.

56

1	UNPHU	2.28.89
2	O & M	2.34.17
3	UNAPEC	2.52.13
4	CDEP	3.20.95

Evento N° 13

50 Mts. DORSOFem.

1	Glórialba Pérez	UNPHU	47.67
2	Evelyn Vasquez	UNPHU	1.01.15
3	Patricia D'Óleo	UNPHU	1.01.56
	Wendy Guzmán	UNAPEC	Abandono

Evento N° 14

50 Mts. DORSOMasc.

1	Lawrence Bertrand	UNPHU	34.72
2	Heriberto Jiménez	UNAPEC	34.82
3	Luis Luege	UNPHU	39.36
4	Santo Reyes	UNAPEC	46.88
5	Gerónimo Queli	O&M	54.66
6	Wilhem Geldes	UNPHU	1.07.17
7	Eduardo Espinal	O&M	1.13.26
8	Luis Peña	CDEP	Descalif.

Evento N° 15

100 Mts. MARIPOSAFem.

(NO SE CELEBRÓ)

Evento N° 16

100 Mts. MARIPOSAMasc.

1	Heriberto Jiménez	UNAPEC	1.12.92
2	Luis Luege	UNPHU	1.23.78

Evento N° 17

200 Mts. COMBINADO IND.Fem.

1	Glórialba Pérez	UNPHU	3.50.90
2	Cynthia Aranda	UNPHU	4.29.31

Evento N° 18

200 Mts. COMB. INDIVIDUALMasc.

1	Heriberto Jiménez	UNAPEC	2.42.62
2	Edgardo Rodríguez	O&M	3.00.88
3	Luis Luege	UNPHU	3.09.61
4	Miguel Valdéz	UNPHU	No se tiró

Evento N° 19

100 Mts. PECHOFem.

1	Xiomara Jaquez	UNPHU	1.52.16
2	Patricia D'Óleo	UNPHU	1.59.83

Evento N° 20 100 Mts. PECHO Masc.

1	Ricardo Martínez	UNPHU	1.37.39
2	Lawrence Beltrand	UNPHU	1.48.84
3	Alexis Brugal	UNPHU	1.52.20
4	Migel Valdéz	O&M	
	Pedro Heyaime	UNAPEC	
	Julio Martínez	O&M	
	Roberto Gómez	O&M	
	Marcelo Marte	UNAPEC	

Evento N° 21 RELEVO 4 x 50 Mts. LIBRE Fem.

1	Patricia D'Óleo		
1	Cynthia Aranda	UNPHU	3.09.69
	Xiomara Jaquez		
	Gloria Alba Pérez		

Evento N° 22 RELEVO 4 x 50 Mts. LIBRE Masc.

1	Luis Luege		
	Alexis Brugal		
	Ricardo Martínez	UNPHU	2.08.7
	Lawrence Beltrand		
1	Roberto Gómez		
	Ramón Ruiz	O&M	2.13.10
	Julio Martínez		
	Edgardo Rodríguez		
3	Saulo Reyes		
	Luis Heredia	UNAPEC	2.54.47
	Pedro Heyaime		
	Heriberto Jiménez		

POSICION POR EVENTO DE NATACIONMasculino

								UNPHU	UNAPEC	O&M	CDEP	
		1	2	3	4	5	6					
1	50 Mts. LIBRE	M	UNAPEC	UNPHU	O&M	UNPHU	UNAPEC	CDEP	2	9	4	1
2	100 DORSO	M	UNAPEC	UNPHU	UNPHU	UNPHU	CDEP	UNAPEC	12	8		2
3	50 PECHO	M	O&M	UNPHU	UNPHU	UNPHU	O&M	UNAPEC	12	1	9	
4	100 LIBRE	M	UNAPEC	UNPHU	UNPHU	UNPHU	O&M	UNAPEC	12	8	2	
5	50 MARIPOSA	M	UNPHU	UNPHU	UNAPEC	O&M	O&M	UNPHU	13	4	5	
6	4 x 50 C.I.	M	UNPHU	O&M	UNAPEC	CDEP	--	--	14	8	10	6
7	50 DORSO	M	UNPHU	UNAPEC	UNPHU	UNAPEC	O&M	UNPHU	12	8	2	
8	100 MARIPOSA	M	UNAPEC	UNPHU	-	-	-	-	3	7		
9	200 COM.IND.	M	UNAPEC	O&M	UNPHU	-	-	-	4	7	5	
10	100 PECHO	M	UNPHU	UNPHU	UNPHU	-	-	-	16			
11	4 x 50 LIBRE	M	UNPHU	O&M	UNAPEC	-	-	-	14	8	10	-
<u>Total</u>									122	68	47	9

FEMENINO

		1	2	3	4	5	6					
1	50 Mts. LIERE	F	UNPHU	UNPHU	UNAPEC	UNAPEC	O&M	UNPHU	13	7	2	
2	100 DORSO	F	UNPHU	UNPHU	UNPHU		-	-	16			
3	50 PECHO	F	UNPHU	UNPHU	UNPHU	-	-	-	16			
4	100 LIBRE	F	UNPHU	UNPHU	UNPHU	UNAPEC	-	-	16	3		
5	50 MARIPOSA	F	UNPHU	UNPHU	UNPHU	-	-	-	16			
6	4 x 50 C.I.	F	UNPHU	-	-	-	-	-	14			
7	50 DORSO	F	UNPHU	UNPHU	UNPHU	-	-	-	16			
8	200 COM.IND.	F	UNPHU	UNPHU	-	-	-	-	12			
9	100 PECHO	F	UNPHU	UNPHU	-	-	-	-	12			
10	4 x 50 LIERE	F	UNPHU	-	-	-	-	-	14			
<u>Total Femenino</u>									145	10	2	0
<u>Total General</u>									267	78	49	9

SOFTBOL

El torneo de softbol de la III Universiada Nacional volvió a ser de los más representativo y reñido de las disciplinas programadas.

Nueve equipos disputaron el evento por el sistema de doble eliminación.

Por segundo año consecutivo el equipo representativo de la Universidad Nacional Pedro Henríquez Ureña (UNPHU) se coronó campeón disputando el partido final a UNICA, también por segundo año consecutivo.

La posición final de los equipos fue la siguiente:

1	UNPHU	5 - 1
2	UNICA	3 - 2
3	UNAPEC	4 - 2
4	OEM	2 - 2
5	UTESA	1 - 2
6	UCSD	1 - 2
7	UASD	1 - 2
8	UNIBE	0 - 2
9	UNIREMHOS	0 - 2

RESULTADOS S O F T B O L

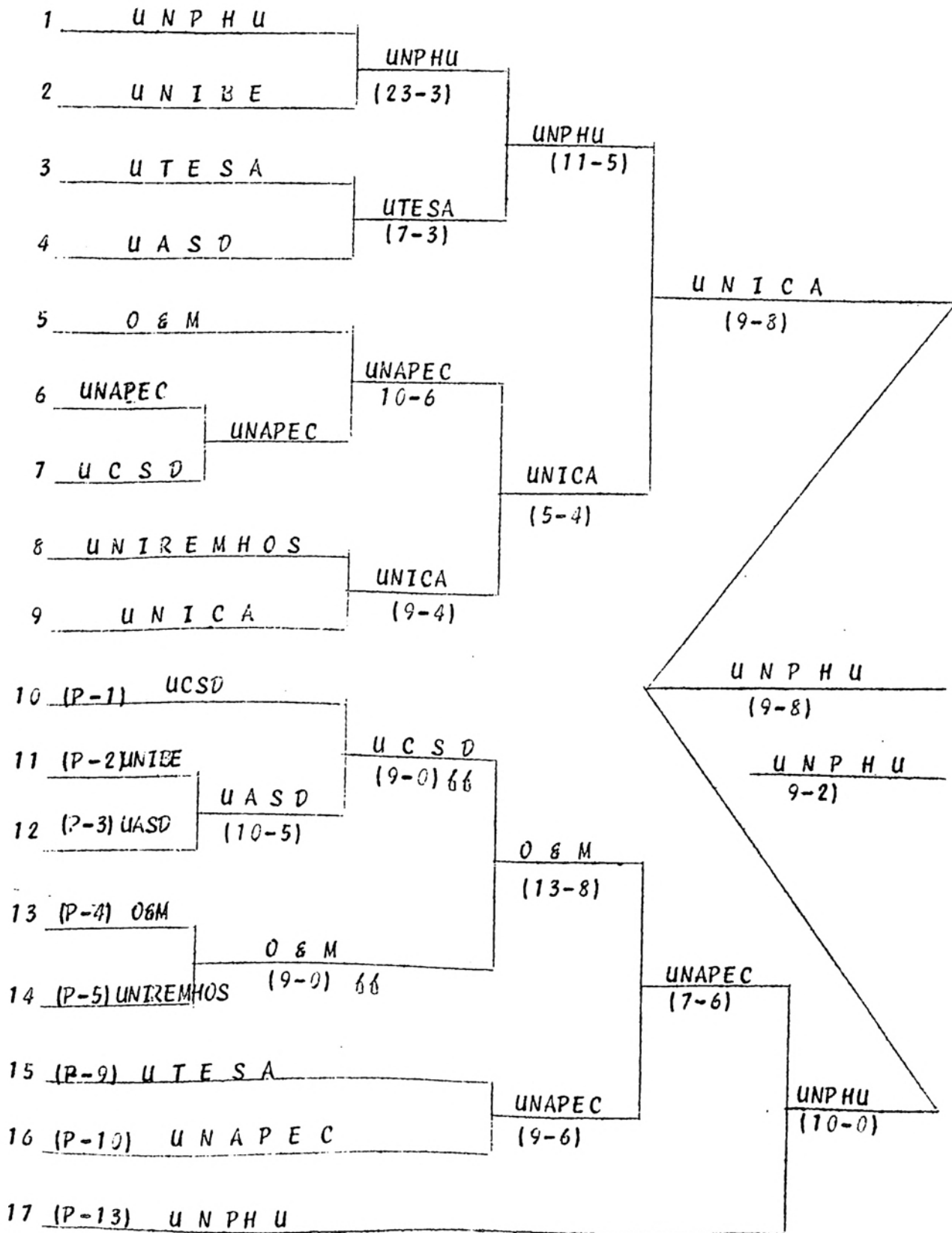

NOMINA DE PARTICIPANTESU C S D

1	Juan Carlos Espinal
2	José Durán
3	César Peña
4	Angelo Hernández
5	Alcíbes Rojas
6	José Manuel Valenzuela
7	Virgilio Jiménez
8	Ramón Tomás Tavares
9	Manuel Amaro Ramírez
10	Héctor Núñez
11	Rubén Larraudi
12	Jaime Victoria
13	José Merán
14	Rubén Amaro
15	Richard Abreu

O & M

1	Oscar Mercedes
2	Elvis Nova
3	José Placeres
4	Tony Lapaix
5	Domingo Morel
6	Modesto Ureña
7	Daniel Martínez
8	Rubén Robles
9	Romeo Bartiz
10	Andrés Almonte
11	Luis Atilés
12	Ramón A. Guzmán
13	Giovanny Mora
14	Dario Morel
15	Manuel Ureña
16	Ramón Díaz
17	Nelson González
18	Alberto Tineo

U N I C A

1	Andrés Rosario
2	Gregorio Carela
3	Genaro Familia
4	Guillermo Vargas
5	Ulises Almonte
6	José Méndez
7	Máximo Pemorizi
8	Bienvenido García
9	Segundo Pérez
10	Enrique Cabrera
11	Germán Peña
12	Rafael Lora
13	Héctor Verigüete

U N A P E C

1	Eduardo Alvarez
2	Héctor Victoria
3	Kelvin Valenzuela
4	Jovanny Pichardo
5	Andrés Ruiz
6	Leonel Peña
7	Francisco Pourie
8	David Silva
9	José González
10	Fernando Martínez
11	Melanio del Valle
12	Tomás Fernández
13	Monchy Oviedo

U T E S A

- 1 Luis Díaz
- 2 Felipe De León
- 3 Rafael Ureña
- 4 José Ramírez
- 5 Rodolfo Graciano
- 6 Fausto Mateo
- 7 Carlos Cruz
- 8 Rafael Mateo
- 9 Fabio Rodríguez
- 10 Victoriano Ventura
- 11 Rafael Fortuna

U N P H U

- 1 Rafael Mota
- 2 Rafael Cuello
- 3 Claudio Almonte
- 4 Luis M. Santana
- 5 Alfredo de
- 6 José Estralla
- 7 Alix Montero
- 8 Guillermo del Monte
- 9 Jhonny Mercedes
- 10 Pedro Hernández
- 11 David Román
- 12 Luis Díaz

U N I B E

- 1 Ramón Pérez
- 2 Amauris Sosa
- 3 Bienvenido Rojas
- 4 José Rojas
- 5 Pavel Aquino
- 6 Romero
- 7 Radham
- 8 Eleder Mota
- 9 Antonio González
- 10 Erick Gutiérrez
- 11 Roberto Cruz

U N I V I R E M H O S

- 1 Fernando Acosta Columna
- 2 Felix A. Tejeda Martínez
- 3 Henry Colón Castillo
- 4 Francisco Cabrera M.
- 5 José N. Andrickson Marte
- 6 Juan Dek C. Moreno Oleaga
- 7 Gustavo Rodríguez
- 8 Manuel A. de los Santos
- 9 Aureliano Perdomo Encarnación
- 10 Rafael Rodríguez Rosa
- 11 Ramón A. Acosta del Rosario
- 12 Juan A. Méndez Faña
- 13 Luis A. Ferreira Alcantara
- 14 Sandino García
- 15 Paulino Rosado
- 16 Octavio B. García

BATEO

			VB	HS	AVE
1	Yovanny Pichardo	UNAPEC	77	72	706
2	Alix Montero	UNPHU	18	11	611
3	José Estrella	UNPHU	23	13	565
4	Luis M. Santana	UNPHU	17	9	529
5	José Placeres	O&M	12	6	500
6	Rafael Cuello	UNPHU	23	11	478
7	Guillermo Vargas	UNICA	13	6	461
8	Rafael Mota	UNPHU	22	10	455

CARRERAS ANOTADAS

1	José Estrella	UNPHU	12
2	Rafael Mota	UNPHU	10
3	Luis M. Santana	UNPHU	9
4	Alix Montero	UNPHU	7

CUADRANGULARES

11	José Estrella	UNPHU	3
2	Yovanny Pichardo	UNAPEC	3
3	Alix Montero	UNPHU	2
4	Alfredo de la Rosa	UNPHU	2
5	Guillermo Vargas	UNICA	2

CARRERAS EMPUJADAS

1	José Estrella	UNPHU	12
2	Yovanny Pichardo	UNAPEC	9
3	David Román	UNPHU	9
4	Alfredo de la Rosa	UNPHU	9
5	Rafael Cuello	UNPHU	9

L A N Z A D O R E S

Ganados y Perdidos

		JG	JP	AVE	
1	Rolando Miranda	UNPHU	2	0	1000
2	Héctor Beriguete	UNICA	2	0	1000
3	Ramón Aquino	UNPHU	3	1	750
4	Melanio del Valle	UNAPEC	1	1	500

HITS CONECTADOS

1	José Estrella	UNPHU	13
2	Yovanny Pichardo	UNAPEC	11
3	Alix Montero	UNPHU	11
4	Rafael Cuello	UNPHU	11
5	Rafael Mota	UNPHU	10

EFFECTIVIDAD

1	Rolando Miranda	UNPHU	3.00
2	Ramón Aquino	UNPHU	3.04
3	Héctor Beriguete	UNICA	4.80

HITS SENCILLOS

1	Alix Montero	UNPHU	9
2	José Estrella	UNPHU	9
3	Rafael Cuello	UNPHU	9
4	Yovanny Pichardo	UNAPEC	6
5	Rafael Mota	UNPHU	6
6	Alfredo de la Rosa	UNPHU	6

PONCHES PROPINADOS

1	Luis Atilas	O&M	6
2	Rolando Miranda	UNPHU	4
3	Ramón Aquino	UNPHU	4
4	Héctor Beriguete	UNICA	3

HITS DOBLE

1	Luis M. Santana	UNPHU	4
2	David Román	UNPHU	3
3	Yovanny Pichardo	UNAPEC	2
4	José Estrella	UNPHU	2
5	Rafael Mota	UNPHU	2

HITS TRIPLES

1	Luis Encarnación	UNICA	2
2	Elvis Nova	O&M	2
3	10 empatados con		1

S O F T B O L

BATEO INDIVIDUAL POR EQUIPOU N I P H U

		VB	CA	CE	HS	AVE.	H1	H2	H3	HR	B	BR	K	TB	SLUG
1	Alix Montero	18	7	6	11	611	9	0	0	2	0	3	0	17	944
2	José Estrella	23	12	12	13	565	9	2	0	3	2	1	0	25	1087
3	Luis M. Santana	17	9	3	9	529	4	4	0	1	5	1	1	16	941
4	Rafael Cuello	23	6	9	11	478	9	0	1	1	3	0	0	16	696
5	Rafael Mota	22	10	3	10	455	6	2	1	1	6	0	0	17	772
6	David Román	20	6	9	8	400	4	3	0	1	3	0	0	14	700
7	Alfredo de la Rosa	23	4	9	9	391	6	1	0	2	1	0	0	16	696
8	Pedro Hernández	4	3	0	1	250	1	0	0	0	2	0	0	1	250
9	Guillermo del Monte	4	2	2	1	250	0	0	0	1	2	0	2	4	1000
10	José Paulino	4	2	0	1	250	1	0	0	0	3	0	1	1	250
11	Larry Díaz	4	1	0	1	250	1	0	0	0	0	0	0	1	250
12	Jhonny Mercedes	19	3	3	3	158	3	0	0	0	2	0	1	3	158
13	Miguel Jazmín	1	0	0	0	000	0	0	0	0	1	0	0	0	000
14	Javier Polanco	2	0	0	0	000	0	0	0	0	0	0	0	0	000
15	Jim Mercedes	3	0	0	0	000	0	0	0	0	0	0	0	0	000
16	Luis Díaz	0	0	0	0	000	0	0	0	0	0	0	0	0	000
TOTALES		187	65	56	78	417	52	12	2	12	30	5	5	130	695

U N I C A

		VB	CA	CE	HS	AVE.	H1	H2	H3	HR	B	BR	K	TB	SLUG
1	Guillermo Vargas	13	0	1	6	461	3	1	0	2	0	1	1	13	1000
2	Andres Rosario	12	1	1	5	416	5	0	0	0	0	0	1	5	416
3	German Peña	10	1	3	4	400	4	0	0	0	0	0	0	4	400
4	Luis Encarnación	10	2	3	4	400	1	1	2	0	0	0	0	9	900
5	Máximo Demorizi	14	3	2	5	357	4	0	0	1	1	0	1	8	571
6	César Rodríguez	3	1	0	1	333	1	0	0	0	0	0	0	1	333
7	Bienvenido García	4	1	0	1	250	1	0	0	0	0	0	0	1	250
8	Gregorio Carela	13	3	0	3	231	3	0	0	0	1	1	0	3	231
9	José Méndez	9	1	0	2	222	2	0	0	0	0	0	1	2	222
10	Ulises Almonte	11	3	0	7	182	1	1	0	0	0	0	0	3	273
11	Genaro Familia	13	0	1	2	154	2	0	0	0	0	0	1	2	154
12	Enrique Cabrera	1	0	0	0	000	0	0	0	0	0	0	0	0	000
13	Eugenio Zapata	3	1	0	0	000	0	0	0	0	0	0	0	0	000
14	Segundo Pérez	4	0	0	0	000	0	0	0	0	0	0	0	0	000
TOTALES		120	22	14	35	292	27	3	2	3	2	2	5	48	400

UTESA

	VB	CA	CE	HS	AVE.	H1	H2	H3	HR	B	BR	K	TB	SLUG
1 Victoriano Ventura	3	1	0	2	667	1	1	0	0	1	0	0	3	1000
2 Carlos Acevedo	3	2	4	2	667	0	0	1	1	1	0	0	7	2333
3 Luis Díaz	4	1	0	2	500	2	0	0	0	0	0	0	2	500
4 José Ramírez	4	0	0	2	500	2	0	0	0	0	0	0	2	500
5 Fausto Mateo	4	0	1	2	500	1	0	1	0	0	0	0	4	1000
6 Felipe De León	3	2	2	1	333	1	0	0	0	1	0	0	0	333
7 Víctor Calderón	3	1	1	1	333	1	0	0	0	0	0	0	1	333
8 Rodolfo Graciano	8	0	2	2	250	2	0	0	0	0	0	0	2	250
9 Rafael Mateo	4	1	0	1	250	1	0	0	0	1	0	0	1	250
10 Ramón Sepúlveda	4	1	0	1	250	1	0	0	0	0	0	0	1	250
11 Fabio Rodríguez	5	1	0	1	200	1	0	0	0	0	0	0	1	200
12 Rafael Ureña	4	0	0	0	000	0	0	0	0	0	0	0	0	000
13 Carlos Cruz	6	0	0	0	000	0	0	0	0	1	0	0	0	000
14 Marino Cabral	2	0	0	0	000	0	0	0	0	0	0	0	0	000
15 Ramón Del Carmen	2	0	0	0	000	0	0	0	0	0	0	1	0	000
TOTALES	59	10	11	17	288	12	1	2	2	5	0	1	28	475

UNAPEC

	VB	CA	CE	HS	AVE	H1	H2	H3	HR	B	BR	K	TB	SLUG
1 Yovanny Pichardo	17	6	9	12	705	6	2	1	3	0	0	0	23	1353
2 José González	10	3	2	4	400	1	1	1	1	3	0	3	10	1000
3 Kelvin Valenzuela	14	3	5	5	357	2	1	1	1	1	0	0	11	786
4 Rocky Oviedo	12	0	2	4	333	2	1	1	0	0	0	2	7	583
5 Eduardo Alvarez	14	6	1	4	286	3	0	0	1	4	1	0	3	286
6 Andres Ruiz	13	1	0	3	231	3	0	0	0	2	0	0	3	231
7 Leonel Peña	17	2	2	3	176	2	1	0	0	1	0	0	6	353
8 Francisco Pourie	14	2	2	2	143	2	0	0	0	2	0	0	2	143
9 Tomás Fernández	9	3	0	1	111	0	1	0	0	4	0	1	2	222
10 Wellington Ortiz	2	0	0	0	000	0	0	0	0	0	0	0	00	000
11 Edwin Tejeda	2	0	0	0	000	0	0	0	0	0	0	0	0	000
12 Héctor Vialet	4	0	0	0	000	0	0	0	0	0	0	0	0	000
TOTALES	133	26	23	38	286	21	7	4	6	17	1	7	71	533

O & M

	VB	CA	CE	HS	AVE.	H1	H2	H3	HR	B	BR	K	TB	SLUG
1 Tony Lapaix	9	6	3	6	666	4	0	0	2	2	0	0	12	1333
2 Andrés Almonte	5	1	0	3	600	3	0	0	0	1	0	0	3	600
3 Elvis Nova	7	3	4	4	571	1	1	2	0	0	0	0	9	1286
4 Domingo Morel	4	0	0	2	500	2	0	0	0	0	0	0	2	500
5 José Placeres	12	5	2	6	500	5	0	0	1	0	0	0	9	750
6 Rubén Robles	4	1	3	2	500	0	0	1	1	0	0	0	7	1750
7 Alberto Tineo	2	1	2	1	500	0	1	0	0	1	0	0	2	1000
8 Rafael Bartiz	2	2	0	1	500	1	0	0	0	1	0	0	1	500
9 Oscar Mercedes	12	2	4	5	417	5	0	0	0	0	1	1	5	417
10 Daniel Martínez	3	1	0	1	333	0	1	0	0	0	0	0	2	667
11 Ramón Díaz	4	1	1	1	250	0	0	0	1	0	0	1	4	1000
12 Darío Morel	2	0	0	0	000	0	0	0	0	2	0	0	0	000
13 Giovany Mora	3	0	0	0	000	0	0	0	0	1	0	0	0	000
14 Romeo Baltriz	3	0	0	0	000	0	0	0	0	0	0	0	0	000
15 Ramón de los Santos	2	0	1	0	000	0	0	0	0	0	0	0	0	000
16 Nelson González	2	2	0	0	000	0	0	0	0	2	0	0	0	000
17 Manuel Ureña	4	0	0	0	000	0	0	0	0	0	0	0	0	000
18 Modesto Ureña	5	2	1	0	000	0	0	0	0	1	0	0	0	000
TOTALES	85	27	21	32	376	22	3	3	4	11	1	2	53	623

UNIBE

	VB	CA	CE	HS	AVE.	H1	H2	H3	HR	B	BR	K	TB	slug
1 Ramón Pérez	2	0	1	1	500	1	0	0	0	0	0	0	1	500
2 Amauris Sosa	2	0	0	1	500	1	0	0	0	0	0	0	1	500
3 Bienvenido Rojas	2	0	1	1	500	1	0	0	0	0	0	0	1	500
4 José Rojas	2	1	0	1	500	0	1	0	0	0	0	1	2	1000
5 Pavel Aquino	3	1	0	1	333	1	0	0	0	0	0	0	1	333
6 Romero	3	1	0	1	333	1	0	0	0	0	0	0	1	333
7 Radhamés	3	0	1	1	333	1	0	0	0	0	0	0	1	333
8 Eleder Mota	0	0	0	0	000	0	0	0	0	0	0	0	0	000
9 Antonio González	3	0	0	0	000	0	0	0	0	0	0	1	0	000
10 Erick Gutierrez	2	0	0	0	000	0	0	0	0	0	0	0	0	000
11 Roberto Cruz	2	0	0	0	000	0	0	0	0	0	0	0	0	000
TOTALES	24	3	3	7	292	6	1	0	0	0	0	2	8	333

III UNIVERSIADA NACIONAL 1992

S O F T B O LL A N Z A D O R E S

		Ining	BE	CP	CL	Efect.	HS	HR	B	K	JP	IG	AVE.	
1	Rolando Miranda	UNPHU	14	66	10	6	3.00	26	1	1	4	2	0	1000
2	Ramón Aquino	UNPHU	23	109	17	10	3.74	28	3	2	4	3	1	750
3	Luis Atilés	O & M	9	46	8	5	3.88	14	0	2	6	1	0	1000
4	Melanio del Valle	UNAPEC	7.2	39	7	5	4.57	9	0	2	2	1	1	500
5	Héctor Berigüete	UNICA	11.2	68	11	8	4.80	16	2	13	3	2	0	1000
6	Rafael Lora	UCSD	4.1	19	3	3	4.85	5	0	1	2	1	0	1000
7	Fernando Martínez	UNAPEC	19	97	20	19	7.00	25	5	13	1	1	2	333
8	Alberto Tineo	O & M	6	27	6	6	7.00	7	2	3	1	1	0	1000
9	Ramón A. Gúzman	O & M	5	28	7	6	8.40	7	2	5	2	0	1	000
10	Antonio Laguna	UNICA	9	46	11	11	8.55	17	1	4	0	0	1	000
11	Aristides Victoriano	UTESA	12.1	68	16	15	9.00	26	3	8	1	0	2	000
12	Felix Castillo	UNAPEC	5	30	10	9	12.60	11	3	2	1	0	1	000
13	Rafael Fortuna	UTESA	3.1	24	9	6	12.61	9	3	2	1	0	0	000
14	José Merán	UCSD	6	38	13	12	14.00	13	2	2	0	0	1	000

RECORD COLECTIVO

		Ining	BE	CP	CL	Efect.	HS	HR	B	K
1	UNPHU	29	175	27	16	3.86	54	4	3	8
2	O & M	22	101	21	17	5.40	28	4	10	9
3	UNICA	90.2	114	22	19	6.43	33	3	17	3
4	UNAPEC	31.2	166	37	33	7.30	45	8	17	4
5	UTESA	15.2	85	25	21	9.39	30	6	10	2
6	UCSD	10.1	55	16	15	10.16	18	2	3	2

Tae Kwon Do

El Tae Kwon Do fué una de las disciplinas de más nivel técnico de la III Universidad Nacional, por la categoría de los competidores.

Fué celebrada en el techado del Club San Lázaro ante un numeroso público que se dio cita en dicha instalación.

La Universidad O&M dominó la mayoría de las categorías para ganar la competencia.

Cuadro de Medallas

		<u>O</u>	<u>P</u>	<u>B</u>	<u>T</u>	<u>TOTAL</u>
1	O & M	9	2	1	12	52
2	UNPHU	2	8	1	11	35
3	UASD	1	1	3	5	11
4	INTEC	0	0	1	1	1

Nómina de Participantes TAE KWON DOUNIVERSIDAD NACIONAL PEDRO HENRIQUEZ URENAMasculino

- 1 Juar Martínez Hernández
- 2 Rafael Concepción
- 3 Dalton Pérez
- 4 Naciris Pérez
- 5 Robert Valdéz
- 6 Hilario Rodríguez
- 7 Eugenio Mateo
- 8 Angel Stalin Carrasco

Femenino

- 1 Josefina Mena
- 2 Virgen Cid. Alberto
- 3 María Esperanza Graciano

UNIVERSIDAD AUTONOMA DE SANTO DOMINGOMasculino

- 1 Héctor B. Rodríguez
- 2 Jesús Ma. De los Santos
- 3 Miguel Reyes del Rosario
- 4 Eddy Rodríguez

Femenino

- 1 Ketty Sánchez

UNIVERSIDAD O&MMasculino

- 1 Rafael Farina
- 2 Reyes Hidalgo
- 3 Máximo Valdéz
- 4 Edra Montero
- 5 Milton Pérez
- 6 José Mora
- 7 Lugo Luna
- 8 Oscar Recio

Femenino

- 1 Lucrecia Martínez
- 2 Jovanny Pérez
- 3 Iris Cabrera
- 4 Lucila De León

INSTITUTO TECNOLOGICO DE SANTO DOMINGO

- 1 Johathan Jiménez

RESULTADOS

F E D E R

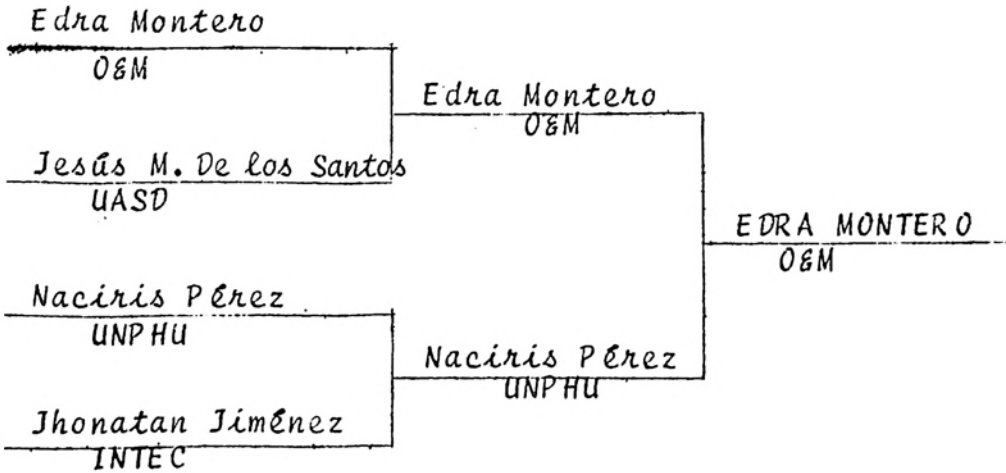

L A I G H T

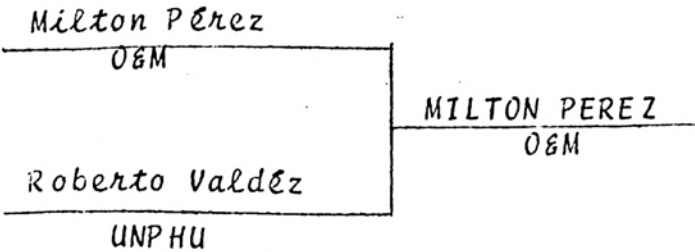

W E L T E R

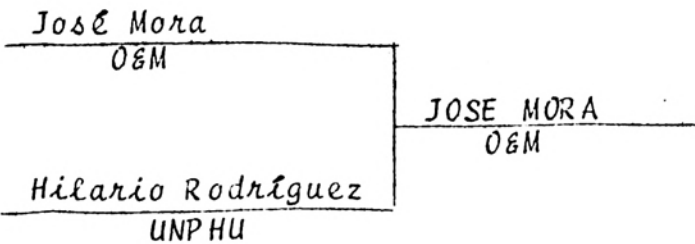

== M I D D L E ==

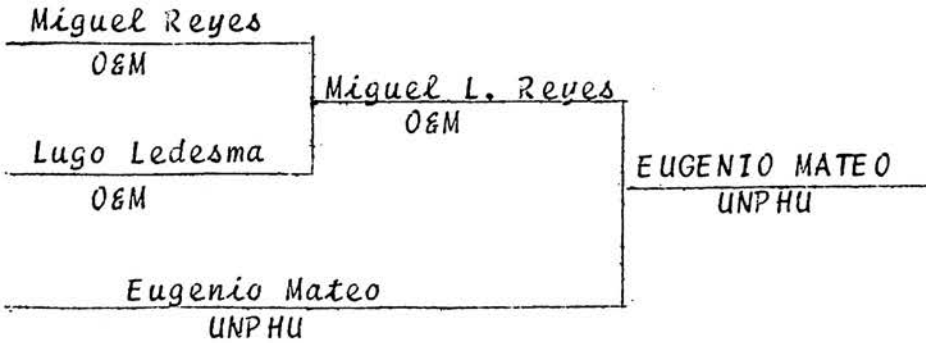

== H E A V Y ==

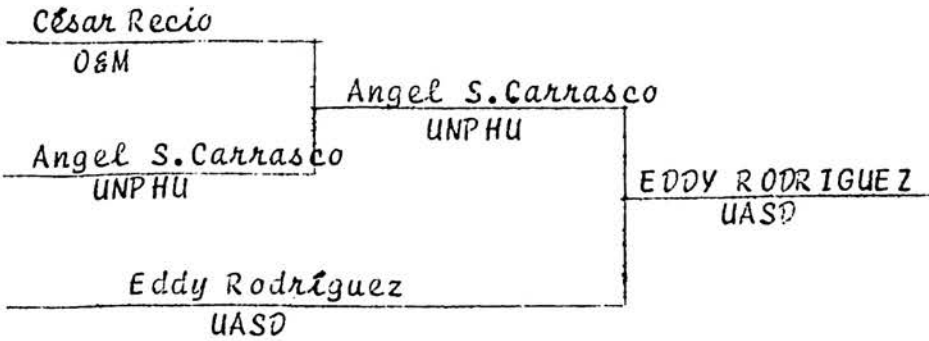

== F I N ==

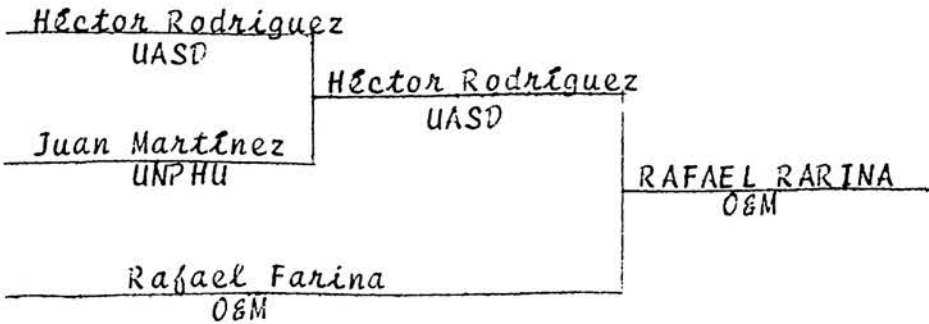

== F L A Y ==

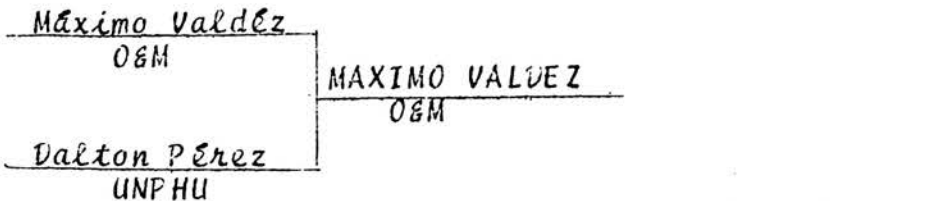

== M I D D L E ==

Miguel Reyes O&M	Miguel L. Reyes O&M	EUGENIO MATEO UNPHU
Lugo Ledesma O&M		
Eugenio Mateo UNPHU		

== H E A V Y ==

César Recio O&M	Angel S. Carrasco UNPHU	EDDY RODRIGUEZ UASD
Angel S. Carrasco UNPHU		
Eddy Rodríguez UASD		

== F I N ==

Héctor Rodríguez UASD	Héctor Rodríguez UASD	RAFAEL FARINA O&M
Juan Martínez UNPHU		
Rafael Farina O&M		

== F L A Y ==

Máximo Valdéz O&M	MAXIMO VALDEZ O&M
Dalton Pérez UNPHU	

BANTAN

Máximo Valdéz
 O&M
 Dalton Pérez
 UNPHU

MAXIMO VALDEZ
 O&M

E E M E N I N O

1er. Peso

Lucrecia Martínez
 O&M
 Josefina Mena
 UNPHU

LUCRECIA MARTINEZ
 P&M

2do. Peso

Johanny Pérez
 O&M
 Virgen Cid Alberto
 UNPHU

VIRGEN CID ALBERTO
 UNPHU

3er. Peso

Ketty Sánchez
 UASD
 Maria Esp. Graciano
 UNPHU

Maria Esp. Graciano
 UNPHU

IRIS CABRERA
 O&M

Iris Cabrera
 O&M

4to. Peso

BYE
 Lucila De León
 O&M

Lucila de León
 O&M

POSICION POR CATEGORIA Y PUNTUACION

		<u>Masculino</u>			O&M	UNPHU	UASD	INTEC
		ORO	PLATA	BRONCE				
1	FEDER	O&M	UNPHU	UASD INTEC	5	3	1	1
2	LAIGHT	O&M	UNPHU	-	5	3		
3	WELTER	O&M	UNPHU	-	5	3		
4	MIDDLE	UNPHU	O&M	UASD	3	5	1	
5	HEAVY	UASD	UNPHU	O&M	1	3	5	
6	FIN	O&M	UASD	UNPHU	5	1	3	
7	FLAY	O&M	UNPHU	-	5	3		
8	BANTAN	O&M	UNPHU	-	5	3		
<i>Total Masculino-----</i>					34	24	10	1

		<u>Femenino</u>			O&M	UNPHU	UASD	INTEC
		ORO	PLATA	BRONCE				
1	1er. PESO	O&M	UNPHU	-	5	3		
2	2do. PESO	UNPHU	O&M	-	3	5		
3	3er. PESO	O&M	UNPHU	UASD	5	3	1	
4	4to. PESO	O&M	-	-	5			
<i>Total Femenino-----</i>					18	11	1	0
<i>Total General-----</i>					52	35	11	1

TENIS

La competencia de TENIS de la III Universidad Nacional fueron celebradas en las canchas de la Universidad Nacional Pedro Henríquez Ureña (UNPHU).

Se inscribieron oficialmente y participaron - cinco Instituciones en la rama masculina: OEM, UNIBE, UNPHU, UNAPEC, INTEC. En la rama femenina se inscribieron oficialmente tres instituciones: UNPHU, OEM y UNAPEC. Una jugadora de UNAPEC y otra de la OEM se presentaron al inicio de la competencia pero no participaron aduciendo que esperaban la otra compañera.

La individual femenina se celebró y el Comité Organizador decidió dejar desierto los eventos de doble mixto, doble femenino y copa universitaria femenina.

La representación de OEM en la rama masculina se llevó los máximos honores; lo mismo que la femenina de la UNPHU.

Cuadro Final de Medallas

	<u>O</u>	<u>P</u>	<u>B</u>	<u>T</u>
O & M	3	0	0	3
UNPHU	1	3	3	7
UNIBE	0	1	1	2
INTEC	0	0	1	1
UNAPEC	0	0	0	0

Nómina de Participantes

UNPHU

Masculino

- 1 *Manuel Valdéz
- 2 José R. González
- 3 Rolando Olivares
- 4 Fernando Sánchez

Femenino

- 1 Paula Arias
- 2 Rosanna Olivares
- 3 Nancy Mejía
- 4 Maxiel Paulino

O & M

Masculino

- 1 Pedro Pablo Ogando
- 2 Rafael Cruz
- 3 *Virgilio Barbosa

Femenino

- 1 *Mayra Martínez
- 2 *Flor Angel Cruz Gastón

UNAPEC

Masculino

- 1 Persio Drullard Espinal
- 2 *Eric Beras Pichardo

Femenino

- 1 *Ruth Peña
- 2 *Ruth Gabarot

INTEC

- 1 Omar Pérez
- 2 Rahuél Alvarez
- 3 Fermin Moore
- 4 Enrique Montero
- 5 Horacio Stagno

UNIBE

- 1 Generoso Castillo
- 2 Wen Sheng Chang
- 3 Jaime Alfonso Moreta Matos
- 4 Francisco José Moole Batista

* No se presentaron a la competencia.

<u>Cuadro de Participación</u>			
UNPHU	4	4	8
O & M	3	2	5
UNAPEC	2	2	4
INTEC	4	0	4
UNIBE	<u>4</u>	<u>0</u>	<u>4</u>
	17	8	25

INDIVIDUAL MASCULINO

1992

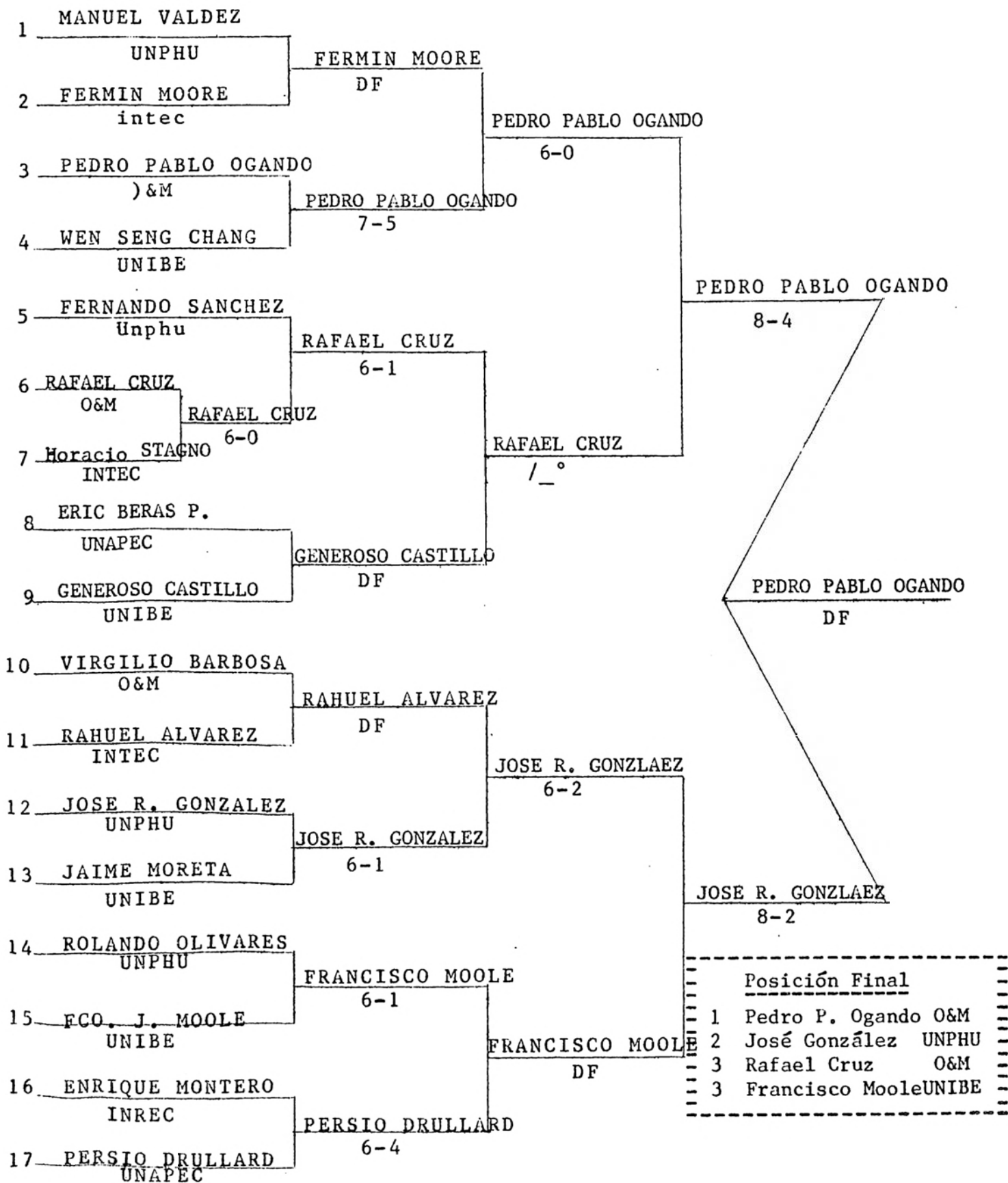

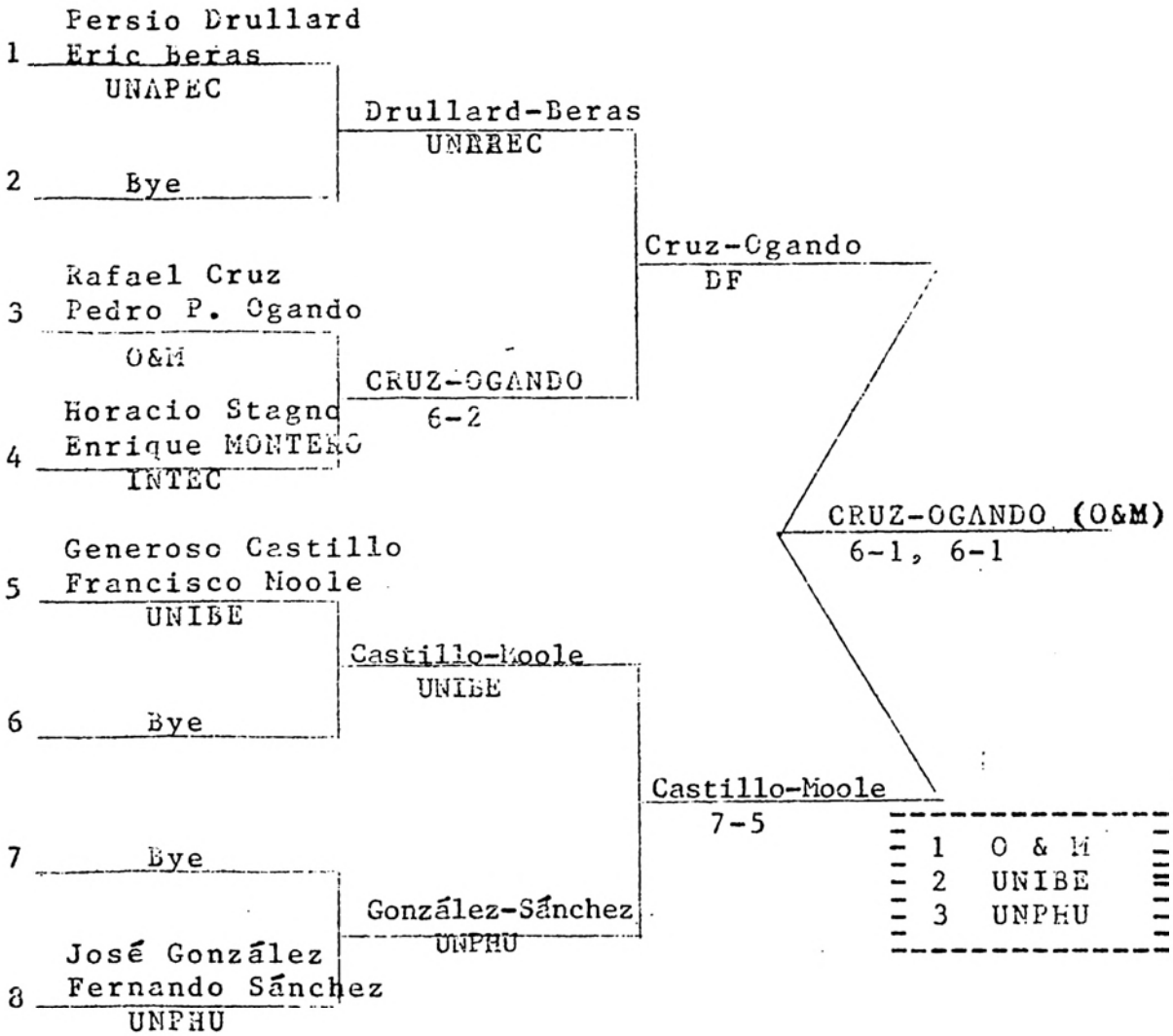

CRUZ-OGANDO (O&M)
6-1, 6-1

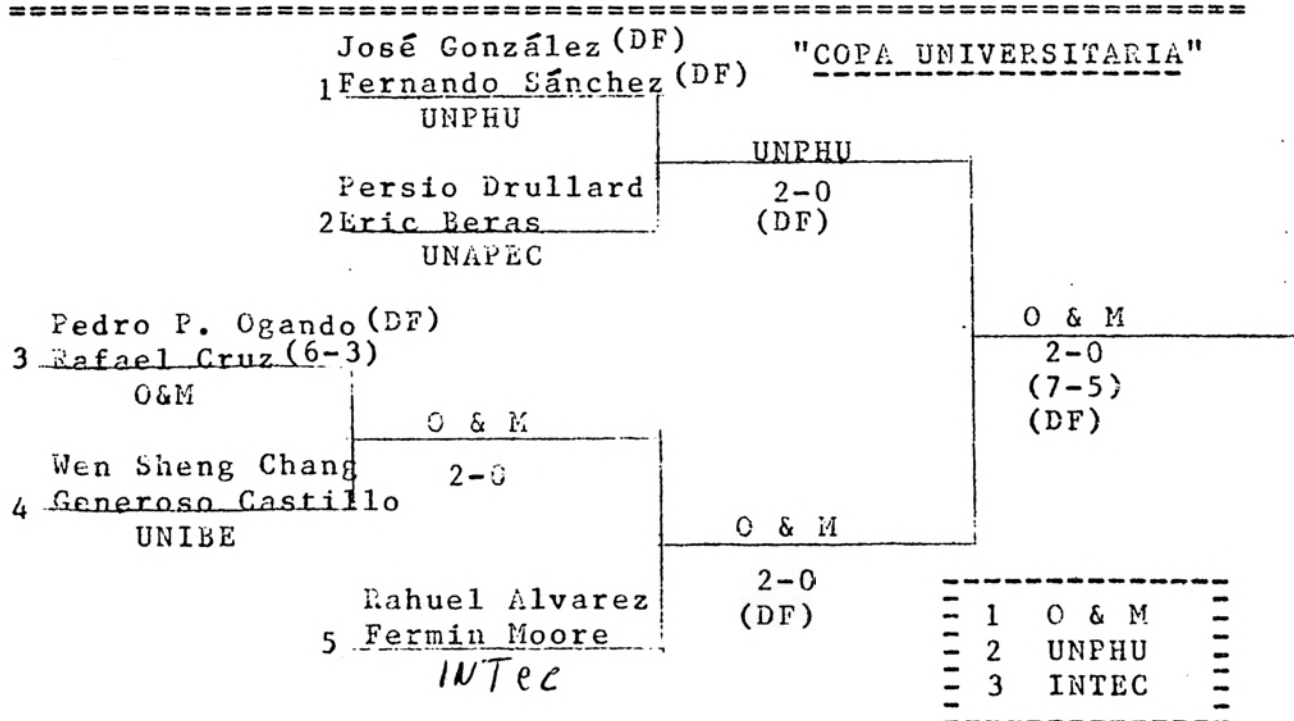

INDIVIDUAL FEMENINO

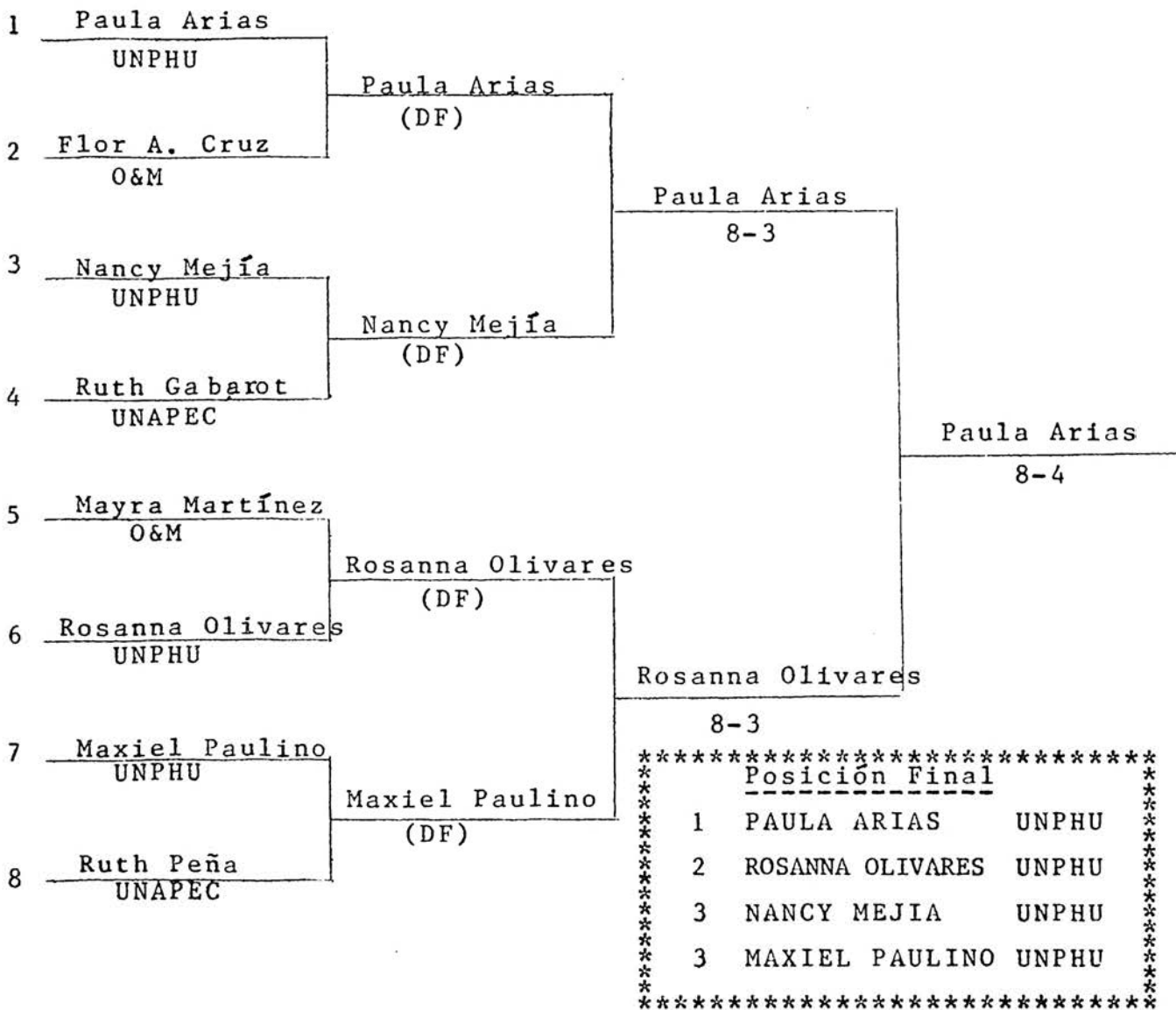

POSICION FINAL POR EVENTO

INDIVIDUAL MASC.	O & M	UNPHU	O&M UNIBE
DOBLE MASCULINO	Ø & M	UNIBE	UNPHU
COPA UNIV. MASC.	O & M	UNPHU	INTEC
INDIVIDUAL FEMENINO	UNPHU	UNPHU	UNPHU UNPHU

DOBLE FEMENINO

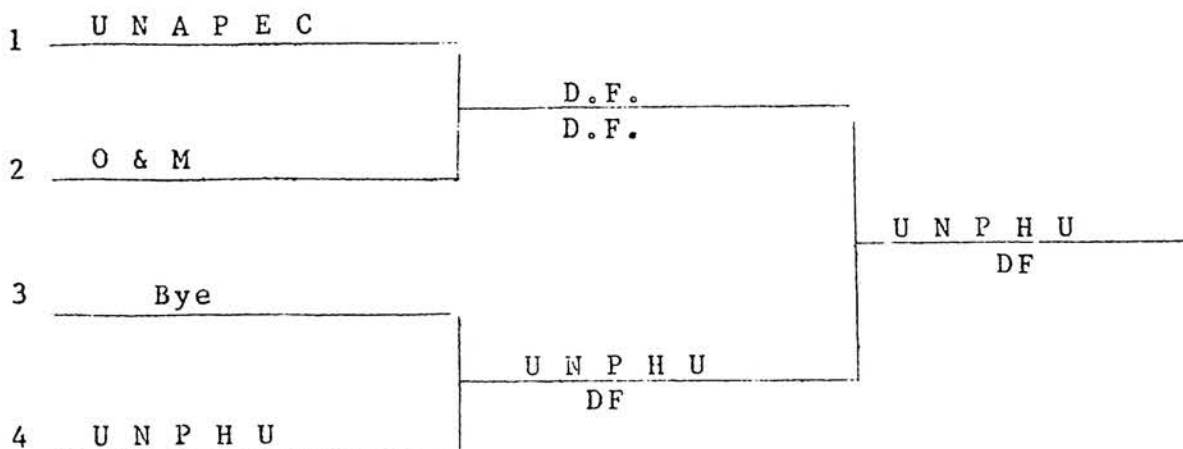

DOBLE MIXTO

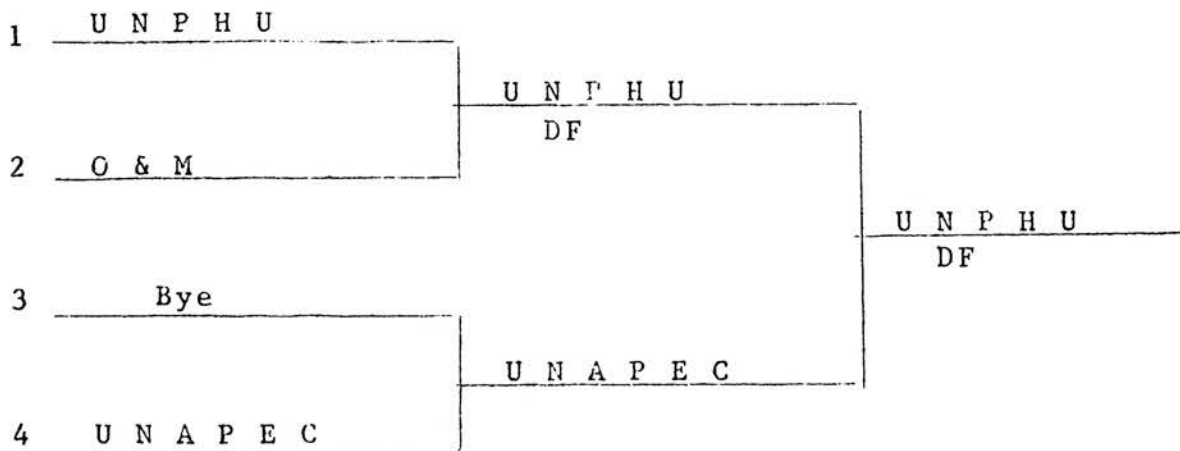

COPA UNIVERSITARIA FEMENINA

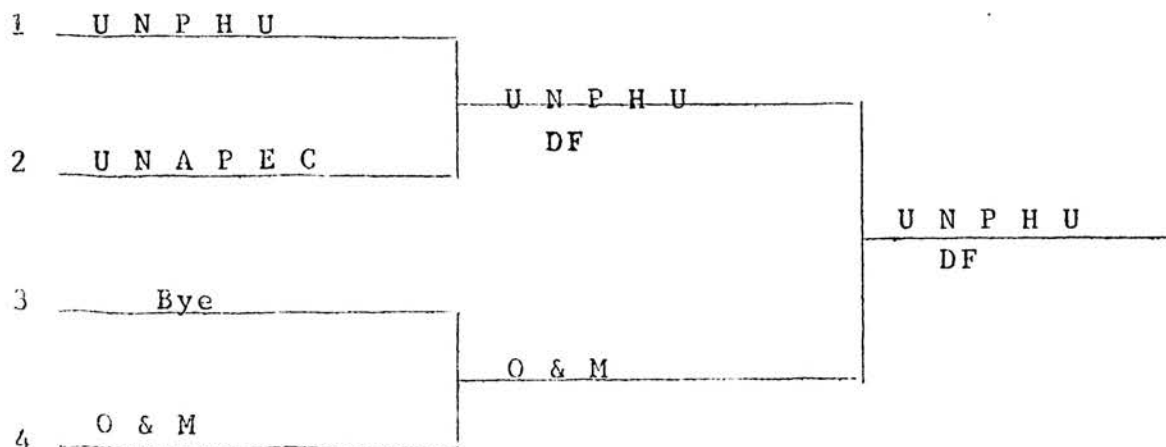

NOTA: Estos tres eventos aunque O&M y UNAPEC se habían inscrito oficialmente, pero el día de la competencia no asistieron. La UNPHU decidió no computar estos resultados.

Tennis de Mesa

El Tennis de Mesa fué una actividad muy representativa. Participaron jugadores de Universidades. - Fué celebrado en los salones de uso multiple de la UNPHU.

UTESA ganó las dos ramas por equipo

Luis Alexis de la cruz, de la UNPHU, fué el jugador más sobresaliente a nivel individual.

POSICION FINAL POR EQUIPO

<u>MASCULINO</u>	<u>FEMENINO</u>
1 UTESA	1 UTESA
2 UASD	2 UASD
3 UNPHU	3 UNPHU
3 INTEC	4 INTEC
5 UNIBE	
PUCMM	
UNIREMHOS	

NOMINA DE PARTICIPANTES DE TENIS DE MESA

80

M A S C U L I N O

<u>U A S D</u>	<u>U N I B E</u>	<u>U N P H U</u>
1 Leonardo Ramos	1 Adrian N��nez	1 Luis Alexis de la Cruz
2 Ram��n Reynoso	2 C��sar Pe��a	2 Carlos Ba��z
3 Omar Silva	3 Marcos Barinas	3 Ulises Espailat
4 Dante Cubitte	4 Leicester Florim��n	4 Vladimir S��nchez

<u>I N T E C</u>	<u>U T E S A</u>	<u>P U C M M</u>
1 Mag��n D��az	1 Reynaldo Moronta	1 V��ctor Sahad
2 Jhonny Lee	2 Luis M��. Paulino	2 Rub�� Santana
3 David Vidal	3 E��berto Espinal	
4 Pedro Uribe		<u>U N I R E M H O S</u>
5 Antony de los Santos		1 Daniel Landr��n
		2 Miguel Rodr��guez

F E M E N I N O

<u>U A S D</u>	<u>I N T E C</u>
1 Carmen Bejaran	1 Yira Camacho
2 Mar��a Isabel Fabian	2 Yesenia Cruz
3 Rosa Evelin	
4 Ma ..	

<u>U N P H U</u>	<u>U T E S A</u>
1 Julia Perdomo	1 Alba Acosta
2 Dolores Aracera	2 Olga Vila
	3 Rosa Iris Gago Pe��a

<u>P U C M M</u>
1 C��ndida Joaqu��n

RESULTADOS POR EQUIPO

Masculino

GRUPO "A"

		1	2	3	TOTAL
1	UNPHU		3	3	6
2	UASD	1		3	4
3	UNIREMOS	0	0		0

GRUPO "B"

		1	2	3	4	TOTAL
1	INTEC		3	3	3	9
2	UTESA	2		3	3	8
3	UNIBE	0	1		3	4
4	PUCMM	0	0	0		0

F I N A L

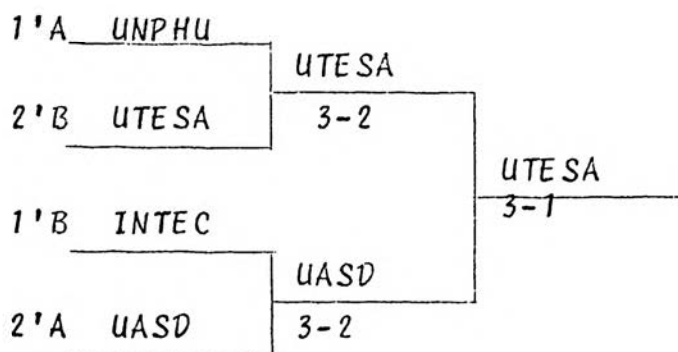

```

*****
* Posición Final *
* 1 UTESA *
* 2 UASD *
* 3 UNPHU *
* 3 INTEC *
* 5 UNIBE *
* 6 PUCMM *
* UNIREMHOS *
*****
  
```

FEMENINO

		1	2	3	4	TOTAL
1	UTESA		3	3	3	9
2	UASD	2		3	3	8
3	UNPHU	0	0		3	3
4	INTEC	0	0	0		0

INDIVIDUAL MASCULINO

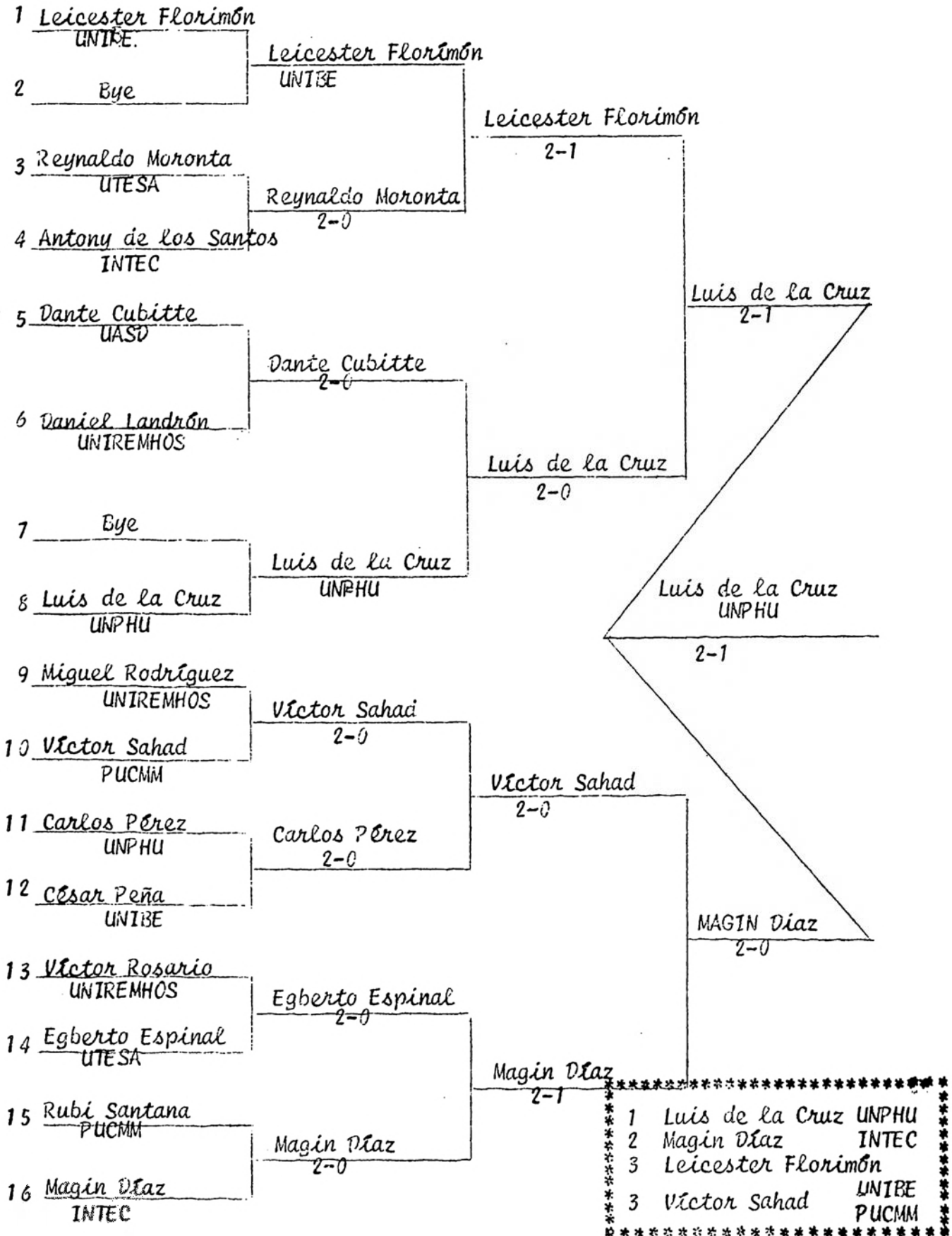

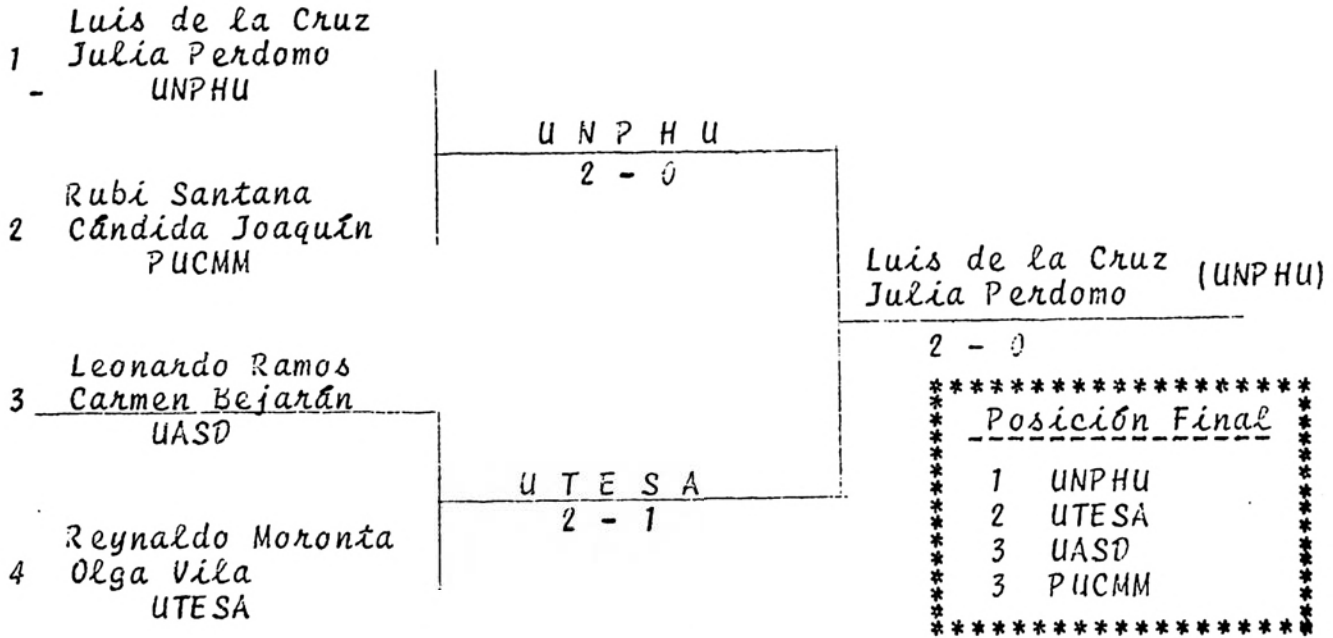

DOBLE MASCULINO

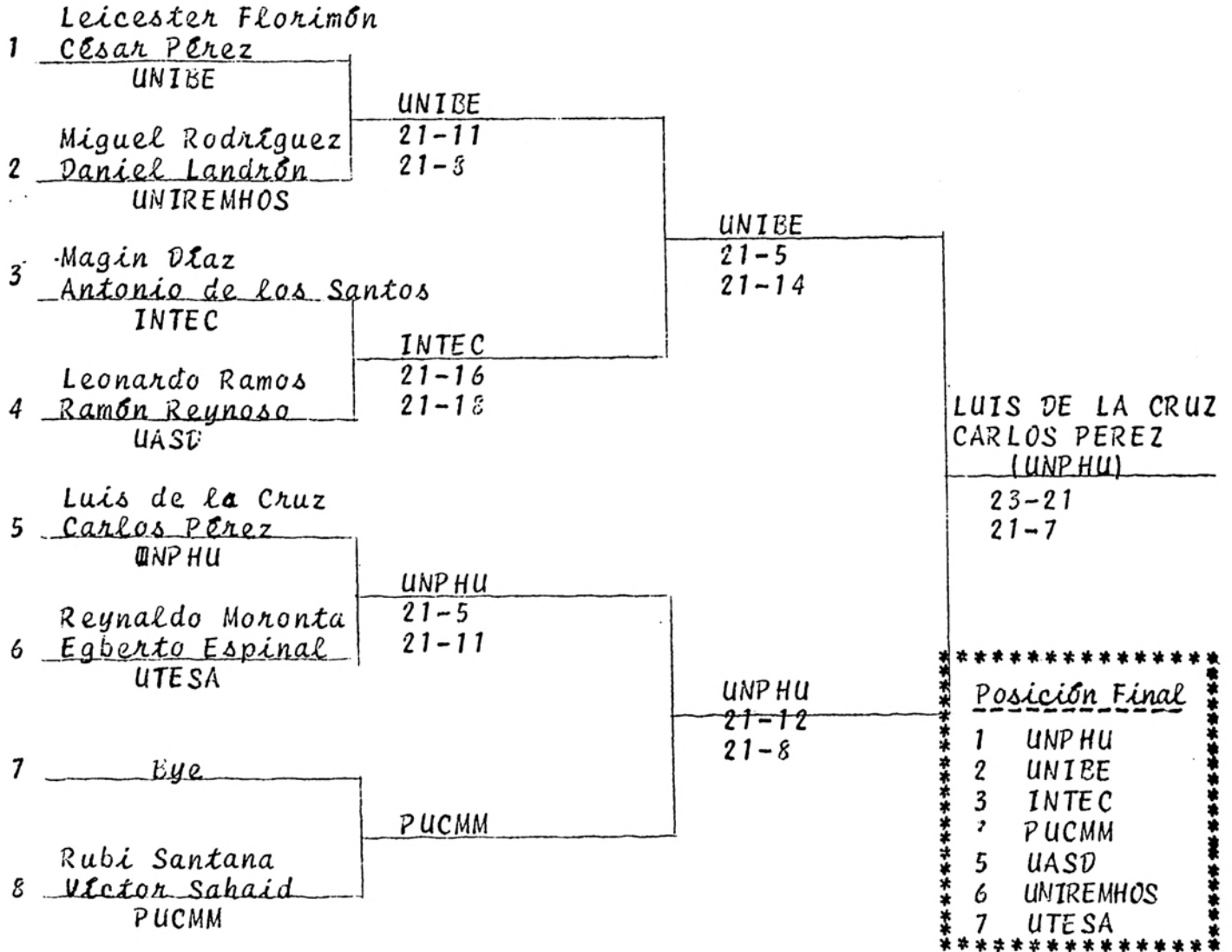

INDIVIDUAL FEMENINO

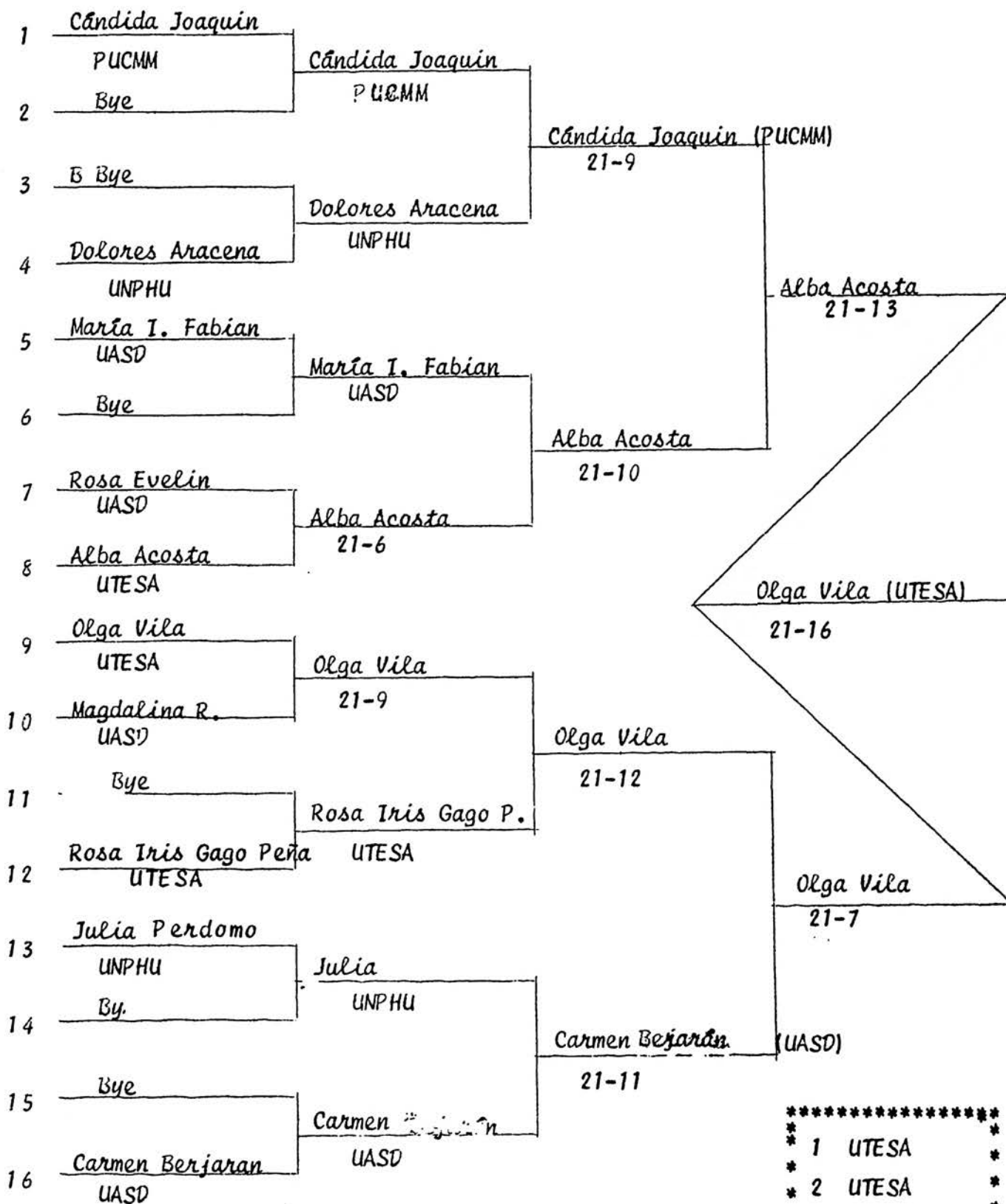

* 1 UTESA *
* 2 UTESA *
* 3 PUCMM *
* 5 UASD *

DOBLE FEMENINO

1	OLGA Vila Alba Acosta UTESA	U T E S A 2-0	Olga Vila Alba Acosta (UTESA) 2 - 0
2	Julia Perdomo Dolores Aracena UNPHU		
3	Vira Camacho Yessenia Cruz INTEC	U A S D 2 - 0	
4	Carmen Bejarán Rosa Evelín UASD		

```

*****
** Posición Final **
**-----**
** 1 U T E S A **
** 2 U A S D **
** 3 U N P H U **
** 3 I N T E C **
*****
    
```

MEDALLAS POR EVENTO

		ORO	PLATA	BRONCE
1	INDIVIDUAL MASCULINO	UNPHU	INTEC	UNIBE PUCMM
2	DOBLE MASCULINO	UNPHU	UNIBE	PUCMM INTEC
3	EQUIPO MASCULINO	UTESA	UASD	UNPHU INTEC
4	DOBLE MIXTO	UNPHU	UTESA	UASD PUCMM
5	INDIVIDUAL FEMENINO	UTESA	UTESA	UASD PUCMM
6	DOBLE FEMENINO	UTESA	UASD	INTEC UNPHU
7	EQUIPO FEMENINO	UTESA	UASD	UNPHU

```

*****
** CUADRO GENERAL DE MEDALLAS **
**-----**
**   O   P   B   TOTAL **
** 1  U T E S A   4   2   0   6 **
** 2  U N P H U   3   0   3   6 **
** 3  U A S D     0   3   2   5 **
** 4  I N T E C   0   1   3   4 **
** 5  P U C M M   0   0   4   4 **
** 6  U N I B E   0   1   1   2 **
*****
    
```

III UNIVERSIADA NACIONAL 1992

VOLEIBOL

El Voleibol como de costumbre, fué el deporte más representativo, participaron 17 equipos: 10 en la rama masculino y 7 en la femenina.

El evento se celebró en las canchas de la Universidad Nacional Pedro Henríquez Ureña (UNPHU), O & M, Pabellón de Voleibol y Club San Lázaro.

La representación de la UNPHU obtuvo los máximos honores al ganar *invicto* las dos ramas.

Nuestro agradecimiento al Club San Lázaro que gentilmente nos cedió sus instalaciones para la semifinales y finales.

POSICION FINAL DE LOS EQUIPOS

<u>MASCULINO</u>		<u>FEMENINO</u>	
1	UNPHU (5-0)	1	UNPHU (5-0)
2	UASD (3-1)	2	UASD (3-1)
3	UTESA (1-1)	3	O & M (1-2)
4	O & M (1-1)	4	UNAPEC (2-2)
5	PUCMM (2-1)	5	PUCMM (1-2)
6	UNIBE (1-2)	6	UTESA (0-2)
7	UNAPEC (1-1)	7	UCSD (0-3)
8	UCSD (0-2)		
9	COEP (0-2)		
10	UNICA (0-3)		

VOLEIBOL MASCULINORESULTADOSGRUPO "A"

	1	2	3	4	JG	JP	PTOS	SG	SP	%	PF	PC	%
1 UNPHU		15-11 15-9	16-14 17-15	15-0 15-0	3	0	6	6	0	6.0	93	49	1.9
2 PUCMM	11-15 9-15		8-15 15-10 15-11	15-0 15-0	2	1	5	4	3	1.3	88	66	1.3
3 UNIBE	14-16 15-17	15-8 10-15 11-15		15-0 15-0	1	2	4	3	4	0.8	95	71	1.3
4 UNICA	0-15 0-15	0-15 0-15	0-15 0-15		0	3	0	0	6	0.0	0	90	0.0

GRUPO "B"

	1	2	3	JG	JP	PTOS	SG	SP	%	PF	PC	%
1 O & M		-	15-1 15-2	1	0	2	2	0	2.0	30	3	10.0
2 UTESA	-		15-5 15-10	1	0	2	2	0	2.0	30	15	2.0
3 UCSD	1-15 2-15	5-15 10-15		0	2	2	0	4	0.0	18	60	0.3

GRUPO "C"

	1	2	3	JG	JP	PTOS	SG	SP	%	PF	PC	%
1 UASD		15-9 15-3	15-0 15-0	2	0	4	4	0	4.0	60	12	5.0
2 UNAPEC	9-15 3-15		15-4 15-3	1	1	3	2	2	1.1	42	37	1.0
3 CDEP	0-15 0-15	4-15 3-15		0	2	1	0	4	0.0	7	60	0.1

SEMIFINAL Y FINAL

UNPHU	
UTESA	UNPHU
	15-11
	9-15
	18-16
O & M	UNPHU
	16-14
	15-13
UASD	UASD
	15-13
	13-15
	15-9

*****		Posición Final		*****	
1	UNPHU	(5-0)			
2	UASD	(3-1)			
3	UTESA	(1-1)			
4	O & M	(1-1)			
5	PUCMM	(2-1)			
6	UNIBE	(1-2)			
7	UNAPEC	(1-1)			
8	UCSD	(0-2)			
9	CDEP	(0-2)			
10	UNICA	(0-3)			
*****				*****	

VOLEIBOL FEMENINO

G R U P O "A"

RESULTADOS

		1	2	3	4	JG	JP	PTOS.	SG	SP	%	PF	PC	%
1	UNPHU		15-3 15-3	15-4 15-2	15-3 15-0	3	0	6	6	0	6.0	90	15	6.0
2	UNAPEC	3-15 3-15		15-11 15-12	15-1 15-11	2	1	5	4	2	2.0	66	65	1.0
3	PUCMM	4-15 2-15	11-15 12-15		15-0 15-0	1	2	4	2	4	0.5	59	60	0.9
4	UCSD	3-15 0-15	1-15 11-15	0-15 0-15		0	3	2	0	6	0.0	15	90	0.2

G R U P O "B"

		1	2	3	4	JG	JP	PTOS.	SG	SP	%	PF	PC	%
1	U A S D		10-15 15-6 15-11	15-5 15-5	-	2	0	4	4	1	4.0	70	42	1.7
2	O & M	15-10 6-15 11-15		15-8 15-3	-	1	1	3	3	2	1.5	62	51	1.2
3	UTESA	5-15 5-15	8-15 3-15		-	0	2	2	0	4	0.0	21	60	0.4

SEMIFINAL Y FINAL

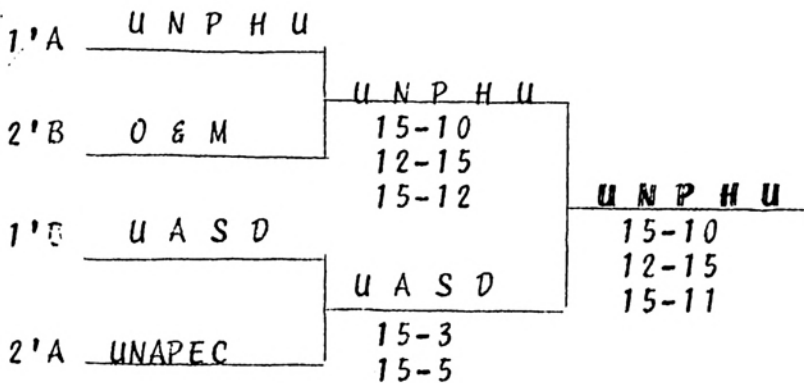

```

*****
* Posición Final *
* 1 UNPHU (5-0) *
* 2 UASD (3-1) *
* 3 O&M (1-2) *
* 4 UNAPEC (2-2) *
* 5 PUCMM (1-2) *
* 6 UTESA (0-2) *
* 7 UCSD (0-3) *
*****
    
```

NOMINA DE LOS EQUIPOS Y PUNTUACION

89

Masculino

<u>U N P H U</u>		<u>O & M</u>		
1	Carlos Cabral	32	1 Luis Méndez	13
2	Cristian Cabral	20	2 Bladimir Alayon	11
3	Danny Asencio	20	3 Amaurys Martínez	5
4	José Capellán	18	4 Eddy Santana	1
5	José Ant. Ramirez	16	5 Leonardo Gil	0
6	Robert Colón	13	6 Máximo Almanzar	0
7	Angel D. Taveras	6	7 Guillermo Mejía	0
8	Rey G. Beltrés	2	8 Agustín Matos	0
9	Waldo Maracallo	2	9 Rafael Acosta	0
10	Richard Veras	0	10 Vidal Lorenzo	0
			11 Julio Pérez	0
			12 José del Carmen	0
<u>U A S D</u>		<u>U N A P E C</u>		
1	José Duarte	19	1 Rafael Soto	9
2	Luis Jon	18	2 Rafael Pérez	6
3	Nehemias García	18	3 Ney Rodríguez	5
4	Teófilo Novas	14	4 Alberto Capellán	5
5	José Betancourt	7	5 Elvis Roger	5
6	Manuel Nova	6	6 Juan José Lugo	2
7	Luis Cartagena	6	7 Eduardo Cotes	2
8	Luis de la Cruz	4	8 Kilvio Cruz	1
9	Julio Castillo	4	9 Julian Reyes	1
10	Rafael Mota	3	10 Félix Morales	0
11	Vicente Zapata	0		
12	Geovanny Ramírez	0		
13	Manuel Reynoso	0		
<u>U T E S A</u>		<u>P U C M M</u>		
1	Mayobanex Pérez	14	1 Marino David F.	11
2	Johnny Castillo	11	2 Harol Petitón	10
3	Abel Acosta	8	3 Luis Ramírez	9
4	Euris Ramírez	6	4 Luis Cueto	8
5	Newton Rivas	6	5 Ebany Petitón	6
6	José Fernández	8	6 Manuel Simó	5
7	Francisco Soriano	5	7 Rodolfo Verdejas	4
8	Carlos Espinal	5	8 Napoleón Pérez	3
9	Alejandro Pérez	3		
10	Alejandro Yeli	2	<u>C D E P</u>	
11	José Acosta	2	1 Eddy Ceballo	2
12	José Castillo	1	2 Iván Acosta	2
			3 Héctor Aybar	1
			4 René Miranda	1
			5 Danilo Mordan	1
			6 Jaime Hereaux	0
<u>U N I B E</u>		<u>U C S D</u>		
1	Milton Castillo	15	1 Noris Toribio	3
2	Eddy Silva	14	2 Iván Mancebo	2
3	Carlos Segura	12	3 Epifanio Lucas	2
4	Raul Mejía	8	4 Geovanny Disla	2
5	Johnny Ramírez	8	5 Neiran Bagz	2
6	Rafael Ramírez	7	6 Leol Tavaréz	2
7	José Fortuna	1	7 Lucas Bladimir	0
8	Rubén Beltrés	0		

NOMINA DE EQUIPOS Y PUNTUACION

90

Femenino

<u>U N P H U</u>		<u>U N A P E C</u>			
1	Rita de la Rosa	35	1	Gina Peña	25
2	Mirlla Castro	34	2	Maritza Robles	10
3	Iris Veras	20	3	Kenia Olivo	8
4	Ana Antonia Núñez	19	4	Carolina Miranda	8
5	Yaneris Frias	18	5	Nelitza Senciñ	4
6	Nurys Zarzuela	18	6	Janette Grullón	4
7	Yasilis Lee	11	7	Angela López	2
8	Niurka Santos	4	8	Belkis Mejía	2
9	Zahira Aybar q	3	9	Angela Méndez	1
10	Carmen Peña	2	10	Nieves Polanco	1
11	Maribel Bernabel	1	11	Nancy de la Cruz	0
12	Luz Hinojosa	1	12	María Guerrero	0
<u>U A S D</u>		<u>P U C M M</u>			
1	Brígida Chavez	19	1	Sñana Polanco	14
2	Erinelda Uribe	14	2	Ginette Pérez	4
3	Glenys Guzmán	13	3	Evelyn Disla	3
4	Yanida Pascual	17	4	Gusy Meregildo	3
5	María Franco	10	5	Bianka Cabrera	3
6	Cristina Chavez	8	6	Ráquel Polanco	1
7	Erenia Franco	6	7	Elena Almonte	1
8	Misetanea Nova	2	8	Jenny Zorrilla	0
9	Rosangy López	2	9	Tania Cabrera	0
10	Rosa Chavez	0	10	Johanny del Carmen	0
11	Míloris Félix	10			
12	Amada de Tesús	0			
<u>O & M</u>		<u>U T E S A</u>			
1	Elis Martínez	22	1	Evelin Matías	7
2	Fanny Fernández	12	2	Cecil Castillo	4
3	Lucy de los Santos	8	3	Santa Francisca	4
4	Juana Colón	6	4	Eduviges Cruz	3
5	María Reynoso	5	5	Felicitá Acevedo	2
6	Kenia Fernández	2	6	Sandy Flor	1
7	Roselin HEREAUX	0	7	Anis Martínez	0
8	Jackeline de los Santos	0	8	Asia Andájar	0
9	Carmen Espinal	0	9	María Jackson	0
10	Luz de Garcia	0	10	Ignacia de la Cruz	0
11	María Encarnaciñ	0	11	Vicenta Ramírez	0
12	Ana M. Castro	0	12	Miosotis Díaz	0
<u>U C S D</u>					
1	Ánabel Cornielle	4			
2	Cristina Gómez	4			
3	Wendy Rodríguez	3			
4	Masiel Rodríguez	3			
5	Claritza Celado	0			
6	Volanda Núñez	0			
7	Sevil Mota	0			
8	Jenny Paulino	0			
9	Ivón Rodríguez	0			
10	Elsa Ma. Santoni	0			
11	Maribel Castillo	0			

P R E M I A C I O N

U N P H U

Campeón Ajedrez Masculino
 Campeón Ajedrez Femenino
 Campeón Baloncesto Masculino
 Campeón Judo Masculino
 Campeón Natación Masculina
 Campeón Natación Femenina
 Campeón Softbol
 Campeón Tenis Femenino
 Campeón Voleibol Masculino
 Campeón Voleibol Femenino
 Sub-Campeón Atletismo Masculino
 Sub-Campeón Atletismo Femenino
 Sub-Campeón Fútbol
 Sub-Campeón Judo Femenino
 Sub-Campeón Tae Kwon Do
 Sub-Campeón Tenis Masculino

O E M

Campeón Atletismo Masculino
 Campeón Baloncesto Femenino
 Campeón Judo Femenino
 Campeón Tae Kwon Do
 Campeón Tenis Masculino
 Sub-Campeón Baloncesto Masculino

U A S D

Campeón Atletismo Femenino
 Campeón Beisbol
 Campeón Fútbol
 Campeón Karate
 Sub-Campeón Baloncesto Femenino
 Sub-Campeón Tenis de Mesa Masculino
 Sub-Campeón Tenis de MESA Femenino
 Sub-Campeón Voleibol Masculino
 Sub-Campeón Voleibol Femenino

U T E S A

Campeón Tenis de Mesa Masculino
 Campeón Tenis de Mesa Femenino
 Sub-Campeón Karate

I N T E C

Sub-Campeón Ajedrez Masculino
 Sub-Campeón Ajedrez Femenino

U N I B E

Sub-Campeón Beisbol

P U C M M

Sub-Campeón Judo Masculino

U N A P E C

Sub-Campeón Natación Masculina
 Sub-Campeón Natación Femenina

U N I C A

Sub-Campeón Softbol

Diplomas

- A los tres primeros lugares de los deportes individuales
- A los integrantes de los equipos campeones.
- A los mejores tableros de Ajedrez.

Diploma Participación -A todos los participantes.